



User Guide

LT-50MAW805/LT-58MAW805/LT-65MAW805

Version 8.1

*For U.S.*

English

*Illustrations in this guide are provided for reference only and may differ from actual product appearance.*

## Copyright

© 2018 Roku, Inc. All rights reserved. ROKU, the ROKU Logo, and "NOW THIS IS TV" are trademarks and/or registered trademarks of Roku, Inc. Material in this User Manual is the property of Roku, Inc., and is protected under US and International copyright and/or other intellectual property laws. Reproduction or transmission of the materials, in whole or in part, in any manner, electronic, print, or otherwise, without the prior written consent of Roku, Inc., is a violation of Roku, Inc.'s rights under the aforementioned laws.

No part of this publication may be stored, reproduced, transmitted or distributed, in whole or in part, in any manner, electronic or otherwise, whether or not for a charge or other or no consideration, without the prior written permission of Roku, Inc.

Requests for permission to store, reproduce, transmit or distribute materials shall be made to both of the following address:

Roku, Inc.  
150 Winchester Circle  
Los Gatos, CA 95032

Product name: **JVC • Roku TV**  
Document name: **JVC • Roku TV** User Guide  
Document revision: 8.1 - U.S English  
Publication date: 07 July, 2021

## FCC Notice

Warning: Changes or modifications to this unit not expressly approved by the party responsible for compliance could void the user's authority to operate the equipment.

NOTE: This equipment has been tested and found to comply with the limits for a Class B digital device, pursuant to Part 15 of the FCC Rules.

These limits are designed to provide reasonable protection against harmful interference in a residential installation. This equipment generates, uses and can radiate radio frequency energy and, if not installed and used in accordance with the instructions, may cause harmful interference to radio communications. However, there is no guarantee that interference will not occur in a particular installation. If this equipment does cause harmful interference to radio or television reception, which can be determined by turning the equipment off and on, the user is encouraged to try to correct the interference by one or more of the following measures:

- Reorient or relocate the receiving antenna.
- Increase the separation between the equipment and receiver.
- Connect the equipment into an outlet on a circuit different from that to which the receiver is connected.
- Consult the dealer or an experienced radio/ TV technician for help.

# Contents

|   |    |
|---|----|
| Safety and Warnings .....   | 1  |
| Welcome .....   | 4  |
| The new standard in Smart TVs .....                                 | 4  |
| Get the most out of your new TV .....                               | 5  |
| Connections and Setup .....   | 8  |
| Main features, Accessories, Specifications .....                    | 8  |
| Front panel, Rear/Side Connections .....                            | 9  |
| Installation .....  | 10 |
| Base Stand Assembly Instruction .....                               | 11 |
| External Connection .....   | 12 |
| Wall Mount .....  | 16 |
| Connecting an antenna, cable, or satellite box .....                | 17 |
| Connecting external equipment with a composite AV video cable ..... | 18 |
| Connecting external equipment with an HDMI® cable .....             | 18 |
| Connecting headphones or a analog sound bar to the TV .....         | 19 |
| Connecting headphones to the Roku Enhanced Voice Remote .....       | 19 |
| Connecting an AV receiver or digital sound bar .....                | 20 |
| Preparing for Internet connectivity .....                           | 20 |
| AC power .....  | 21 |
| Roku remote batteries .....   | 21 |
| Roku TV remote .....  | 21 |
| Panel buttons .....   | 25 |
| Single button .....   | 25 |
| Three buttons .....   | 26 |
| Game-pad style joystick .....                                       | 26 |
| Four buttons .....  | 26 |
| Five buttons (with mute) .....                                      | 27 |
| Five buttons (without mute) .....                                   | 27 |
| Seven buttons .....   | 28 |
| Guided Setup .....  | 29 |
| Starting Guided Setup .....   | 29 |
| Completing Guided Setup .....                                       | 30 |
| Network connection .....  | 32 |
| Activation .....  | 37 |
| Connect your devices .....  | 38 |
| Home screen .....   | 41 |
| Personalize your Home screen .....                                  | 43 |
| Benefits of connecting .....  | 44 |
| Connecting brings out your TV's full potential! .....               | 44 |
| What is streaming? .....  | 45 |
| What if I didn't connect my TV? .....                               | 47 |

|  |    |
|--|----|
| Setting up Antenna TV .....  | 48 |
| How do I set up the TV tuner? .....                                  | 49 |
| Using your TV .....  | 53 |
| Status indicator .....   | 53 |
| Standby mode energy savings .....                                    | 54 |
| Opting in to Smart TV experience (U.S. only) .....                   | 54 |
| Disable Smart TV experience .....                                    | 55 |
| Disable Auto Notifications .....                                     | 55 |
| Watching Antenna TV channels .....                                   | 56 |
| Changing channels .....  | 56 |
| Favorite Channels in non-connected mode .....                        | 57 |
| Smart Guide (U.S. only) .....  | 59 |
| Viewing program information .....                                    | 61 |
| Adjusting settings while watching a show .....                       | 63 |
| Pausing Live TV .....  | 63 |
| Requirements .....   | 63 |
| Enabling Live TV Pause .....   | 64 |
| Using Live TV Pause .....  | 64 |
| Notes about Live TV Pause .....                                      | 66 |
| More Ways to Watch (U.S. only) .....                                 | 66 |
| Using More Ways to Watch .....                                       | 67 |
| Getting the most from More Ways to Watch .....                       | 70 |
| Switching TV inputs .....  | 70 |
| Auto-detecting devices .....   | 70 |
| Adjusting audio/video settings .....                                 | 70 |
| Playing content from USBs storage devices .....                      | 71 |
| Autoplay launch .....  | 71 |
| Playing content from local network media servers .....               | 72 |
| Using your TV in a hotel or dorm room .....                          | 72 |
| About using your TV on a restricted public network .....             | 72 |
| Getting your Roku TV online on a restricted public network .....     | 73 |
| Roku voice remotes (select models only) .....                        | 75 |
| Re-pairing your Roku voice remote .....                              | 75 |
| Checking the Roku voice remote battery level .....                   | 75 |
| Finding your Roku Enhanced Voice Remote .....                        | 76 |
| Changing and previewing the Enhanced Voice Remote finder sound ..... | 77 |
| Adjusting TV settings .....  | 78 |
| Settings menu .....  | 78 |
| Options menu .....   | 79 |
| Options menu settings .....  | 80 |
| Accessibility (U.S. only) .....                                      | 82 |
| Accessibility menu settings .....                                    | 82 |
| Video description through Secondary Audio Program (SAP) .....        | 83 |

|  |            |
|--|------------|
| Advanced audio settings – DTS TruSurround (select models only) .....       | 84         |
| Advanced audio settings menu options – DTS TruSurround .....               | 84         |
| Advanced audio settings – Sonic Emotion Premium (select models only) ..... | 85         |
| Advanced audio settings menu options – Sonic Emotion Premium .....         | 86         |
| Sonic Emotion settings .....   | 86         |
| Advanced picture settings .....  | 87         |
| Advanced picture settings menu options .....                               | 87         |
| Expert Picture Settings (4K models only) .....                             | 89         |
| Changing privacy settings .....  | 90         |
| Advertising .....  | 90         |
| Microphone .....   | 91         |
| <b>My Feed .....</b>   | <b>93</b>  |
| Movies Coming Soon .....   | 93         |
| Movies, TV shows, and people .....   | 93         |
| <b>Searching for something to watch .....</b>                              | <b>94</b>  |
| How do I search? .....   | 95         |
| Keyboard search using the remote .....                                     | 96         |
| Voice Search from a Roku voice remote .....                                | 96         |
| Searching from the Roku mobile app .....                                   | 97         |
| I found a show, now what? .....  | 97         |
| Follow on Roku .....   | 99         |
| Recent Searches .....  | 99         |
| <b>Using the Roku Channel Store .....</b>                                  | <b>100</b> |
| <b>Customizing your TV .....</b>   | <b>102</b> |
| Add TV inputs .....  | 102        |
| Add streaming channels .....   | 102        |
| Rename inputs .....  | 103        |
| Remove unwanted tiles .....  | 104        |
| Rearrange tiles .....  | 105        |
| Change themes .....  | 106        |
| Edit Antenna TV channel lineup .....                                       | 106        |
| Change menu volume .....   | 107        |
| Configure power settings .....   | 108        |
| Power on settings .....  | 108        |
| Auto power savings .....   | 108        |
| Standby LED On/Off .....   | 109        |
| Fast TV start .....  | 109        |
| Configure accessibility (U.S. only) .....                                  | 109        |
| Captions mode .....  | 109        |
| Captions preferred language .....  | 110        |
| Captions style .....   | 110        |

|  |            |
|--|------------|
| Audio Guide settings .....                                 | 112        |
| Changing caption settings (Canada only) .....              | 113        |
| Configuring parental controls .....                        | 115        |
| Creating a parental control PIN .....                      | 115        |
| Blocking Movie Store, TV Store, and News (U.S. only) ..... | 116        |
| Blocking Broadcast TV shows .....                          | 116        |
| What happens when a TV show is blocked? .....              | 122        |
| Changing the parental control PIN .....                    | 123        |
| Resetting parental controls .....                          | 124        |
| <b>More settings .....</b>                                 | <b>125</b> |
| Changing network settings .....                            | 125        |
| Changing ZIP Code .....                                    | 126        |
| Changing time settings .....                               | 126        |
| Scanning for Antenna TV channels again .....               | 127        |
| Setting the HDMI <sup>®</sup> mode (4K models only) .....  | 127        |
| Adjusting external device connections .....                | 128        |
| Using the TV in a home theater .....                       | 129        |
| Turning off the speakers .....                             | 129        |
| Setting up a digital audio connection .....                | 130        |
| Controlling other devices through CEC .....                | 131        |
| Restarting the TV .....                                    | 133        |
| Resetting the TV .....                                     | 133        |
| Reset audio/video settings .....                           | 133        |
| Factory reset everything .....                             | 134        |
| What if I can't access the Factory Reset option? .....     | 134        |
| Network connection reset .....                             | 135        |
| Changing your Roku ChannelStore PIN preference .....       | 135        |
| Getting system updates .....                               | 136        |
| Checking for updates on a connected TV .....               | 137        |
| Getting updates on a non-connected TV .....                | 137        |
| <b>Other devices .....</b>                                 | <b>140</b> |
| Screen Mirroring your phone or tablet .....                | 140        |
| Getting and using the Roku mobile app .....                | 141        |
| Private Listening on the Roku mobile app .....             | 141        |
| Using a universal remote .....                             | 141        |
| <b>FAQ .....</b>   | <b>142</b> |
| <b>Other information .....</b>                             | <b>143</b> |
| Notice .....   | 143        |

# Safety and Warnings

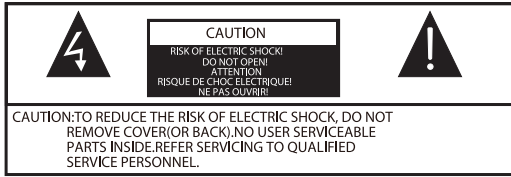

The lightning flash with arrowhead symbol, within an equilateral triangle is intended to alert the user to the presence of uninsulated dangerous voltage within the product's enclosure that may be of sufficient magnitude to constitute a risk of electric shock.



The exclamation point within an equilateral triangle is intended to alert the user to the presence of important operating and maintenance (servicing) instructions in the literature accompanying the appliance.

**WARNING** : TO PREVENT FIRE OR SHOCK HAZARD, DO NOT EXPOSE THIS APPLIANCE TO RAIN OR MOISTURE.  
TO PREVENT THE SPREAD OF FIRE, KEEP CANDLES OR OPEN FLAMES AWAY FROM THIS PRODUCT AT ALL TIMES.

**CAUTION** : TO PREVENT ELECTRIC SHOCK. DO NOT USE THIS POLARIZED PLUG WITH AN EXTENSION CORD, RECEPTACLE OR OTHER OUTLET UNLESS THE BLADES CAN BE FULLY INSERTED TO PREVENT BLADE EXPOSURE.

**WARNING** : This equipment has been tested and found to comply with the limits for a Class B digital device, pursuant to Part 15 of the FCC Rules. These limits are designed to provide reasonable protection against harmful interference in a residential installation. This equipment generates, uses and can radiate radio frequency energy and, if not installed and used in accordance with the instructions, may cause harmful interference to radio communications. However, there is no guarantee that interference will not occur in a particular installation. If this equipment does cause harmful interference to radio or television receptions, which can be determined by turning the equipment off and on, the user is encouraged to try to correct the interference by one or more of the following measures:

- Reorient or relocate the receiving antenna.
- Increase the separation between the equipment and receiver.
- Connect the equipment into an outlet on a circuit different from that to which the receiver is connected.
- Consult the dealer or an experienced radio/TV technician for help.

**CAUTION:** Changes or modifications not expressly approved by the party responsible for compliance with the FCC Rules could void the user's authority to operate this equipment.

THIS DEVICE COMPLIES WITH PART 15 OF THE FCC RULES. OPERATION IS SUBJECT TO THE FOLLOWING TWO CONDITIONS:

(1) THIS DEVICE MAY NOT CAUSE HARMFUL INTERFERENCE, AND (2) THIS DEVICE MUST ACCEPT ANY INTERFERENCE RECEIVED, INCLUDING INTERFERENCE THAT MAY CAUSE UNDESIRE OPERATION.

Supplier's Declaration of Conformity  
 Model No. LT-50MAW805/LT-58MAW805/  
 LT-65MAW805  
 Trade Name: JVC  
 Responsible Party: Russell Distribution Company  
 Address: 7801 Hayvenhurst Avenue, Van Nuys,  
 CA 91406 USA  
 Telephone No. 888-582-8870  
 Contact Information: <https://jvcproducts.com>

**Important Note:**  
 In the spaces below, enter the model and serial number of your television (located at the rear of the television cabinet). Staple your sales receipt or invoice to the inside cover of this guide. Keep this user's guide in a convenient place for future reference. Keep the carton and original packaging for future use.

## Location of the required marking

The rating sheet and the safety caution are on the rear of the unit.

### BATTERY PRECAUTIONS:

- Batteries should not be exposed to excessive heat such as sunshine, fire or the like.
- The remote control unit uses infrared beams to transmit signals, so sunlight or fluorescent light on the remote sensor may shorten operating distance.
- Incorrect use of batteries may cause them to leak or burst. Read the battery warning and use the batteries properly.
- Do not mix old and new batteries.
- Do not mix alkaline, standard (carbon-zinc), or rechargeable (Ni-Cd, Ni-MH, etc.) batteries. Remove batteries if the remote control will not be operated for an extended period of time.

# Safety and Warnings

## IMPORTANT SAFETY INSTRUCTIONS

- 1) Read these instructions.
- 2) Keep these instructions.
- 3) Heed all warnings.
- 4) Follow all instructions.
- 5) Do not use this apparatus near water.
- 6) Clean only with non abrasive dry cloth.
- 7) Do not block any ventilation openings, install in accordance with the instructions.
- 8) Do not install near any heat sources such as radiations, heat registers, stoves, or other apparatus (including amplifiers) that produce heat.
- 9) Do not defeat the safety purpose of the polarized plug. If the provided plug does not fit into your outlet, consult an electrician for replacement of the obsolete outlet.
- 10) Protected the power cord from being walked on or pinched particularly at plugs, convenience receptacles, and the point where they exit from the apparatus.
- 11) Only use attachments/accessories specified by the manufacturer.
- 12) Unplug this apparatus during lighting storms or when unused for long periods of time.
- 13) Refer all servicing to qualified service personnel. Servicing is required when the apparatus has been damaged in any way, such as power-supply cord or plug is damaged, liquid has been spilled or objects have fallen into the apparatus, the apparatus has been exposed to rain or moisture, does not operate normally, or has been dropped.
- 14) Mains plug is used as the disconnect device, the disconnect device shall remain readily operable.
- 15) Do not cover the ventilation opening with items such as newspapers, table-cloth, curtains, etc.
- 16) No naked flame sources, such as lighted candles, should be placed on the apparatus.
- 17) Attention should be drawn to the environmental aspects of battery disposal.
- 18) Use apparatus in moderate climate.
- 19) The apparatus shall not be exposed to dripping or splashing and that no objects filled with liquids, such as vases, shall be placed on the apparatus.
- 20) Use only with a cart, stand, tripod, bracket, or table specified by the manufacturer, or sold with the apparatus. When a cart is used, use caution when moving the cart/apparatus combination to avoid injury from tip-over.



The symbol indicates that dangerous voltages constituting a risk of electric shock are present within this unit.



The symbol indicates that there are important operating and maintenance instructions in the literature accompany this unit.

### WARNING:

To reduce the risk of fire or electric shock, do not expose this apparatus to rain or moisture.

### WARNING:

The batteries shall not be exposed to excessive heat such as, fire or the like.

### WARNING:

The excessive sound pressure from earphones and headphones can cause hearing loss.



The symbol indicates that this product incorporates double insulation between hazardous mains voltage and user accessible parts. When servicing use only identical replacement parts.



This marking indicates that this product should not be disposed with other household wastes. To prevent possible harm to the environment or human health from uncontrolled waste disposal, recycle it responsibly to promote the sustainable reuse of material resources. To return your used device, please use the return and collection systems or contact the retailer where the product was purchased. They can take this product for environmental safe recycling.



# Safety and Warnings

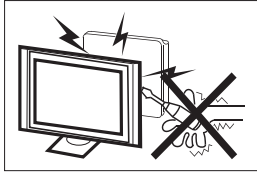

High voltages are used in the operation of this television receiver. Do not remove the cabinet back from your set. Refer servicing to qualified service personnel.

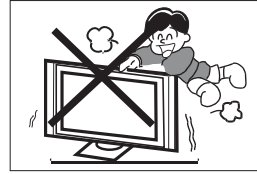

Never stand on, lean on, or suddenly push the television or its stand. You should pay special attention to children. Serious injury may result if it falls.

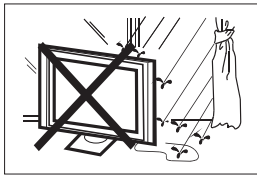

To prevent fire or electrical shock hazard, do not expose the television receiver to rain or moisture.

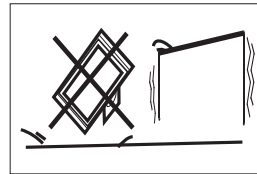

Do not place your television on an unstable cart, stand, shelf or table. Serious injury to an individual, and damage to the television, may result if it falls. Recommended to utilize rear mount screw holes for anti-tipping (hardware not included)



Do not drop or push objects into the television cabinet slots or openings. Never spill any kind of liquid on the television receiver.

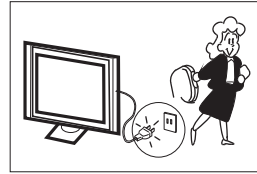

When the television receiver is not used for an extended period of time, it is advisable to disconnect the AC power cord from the AC outlet.

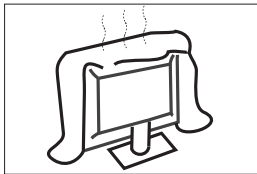

Do not block the ventilation holes in the back cover. Adequate ventilation is essential to prevent failure of electrical components.

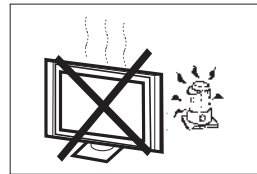

Avoid exposing the television receiver to direct sunlight and other sources of heat. Do not stand the television receiver directly on other products which give off heat, e.g. video cassette players and audio amplifiers. Do not place naked flame sources, such as lighted candles on the television.

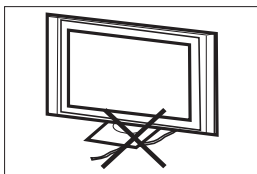

Do not trap the power supply cord under the television receiver.

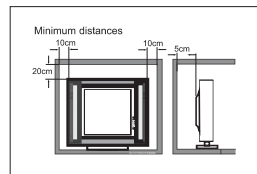

If the television is to be built into a compartment or similar enclosure, the minimum distances must be maintained. Heat build-up can reduce the service life of your television, and can also be dangerous.

# Welcome

Congratulations on the purchase of your new Roku TV ! Discover the joy of endless entertainment. After it's set up, you'll be able to access a world of streaming content channels that may include paid subscription channels like Netflix or free channels like YouTube, Crackle, CNET and literally thousands more.

**Important:** *Your TV receives automatic updates from time to time, enabling new content and features. This edition of the User Guide describes Roku TV version 8.0. To determine the current version of your Roku TV, go to **Settings > System > About** after you complete Guided Setup.*

## The new standard in Smart TVs

Welcome to TV like you've most likely never seen before —a home screen that you can personalize with your favorite devices and streaming channels. Choose from hundreds of thousands of streaming movies and TV episodes, plus music, sports, kids, family, international and much more. You should never run out of things to watch.

**Note:** *A paid subscription or other payment may be required for some channel content. Channel availability is subject to change and varies by country.*

# Get the most out of your new TV

Follow these simple steps to get the most out of your new TV .

## 1. Connect to the Internet

- ☒ It's simple, it's easy, and it will unlock a world of entertainment. All you need is a network connection . There are hundreds of free streaming channels, paid subscription services like Netflix and Spotify , and convenient ways to rent or buy a favorite film or show with , for example, Google Play .

## 2. Pick your favorite streaming channels

- ☒ Find the entertainment you love. From the latest blockbuster movies to your favorite TV shows, with tons of live sports, a broad selection of music streaming channels , popular programming in a dozen international languages, 24x7 live news and so much more, your new Roku TV has your sweet spot. A paid subscription or other payments may be required for some channels.

## 3. Find Antenna TV shows in the Smart Guide

- ☒ *Only in the United States* , use the Smart Guide to see not only what's on TV right now, but what was on up to a week ago, and what will be on in the coming two weeks. And for many over-the-air programs , if you start watching the program after it is already in progress, or you see something you missed in the Smart Guide, you can use More Ways to Watch to find streaming channels where you can see the show from the beginning, find other episodes, or entire seasons of the show, if applicable .

## 4. Use Roku's Smart TV experience to discover More Ways to Watch on other inputs

- ☒ *Only in the United States* , When watching programs from a cable box, Blu-ray player, or other source connected to the HDMI \* or AV inputs, keep an eye out for a notification of streaming channels that offer the program you're currently watching and, if applicable, other episodes, the entire series, or other programs with similar themes.

## 5. Personalize your Home screen

- ☒ Put your favorite streaming channels, and TV inputs front -and -center on the Home screen. No more flipping through inputs or wading through complicated menus. You can even customize the names of each input and move tiles around so your most -often used devices and streaming channels are only a click away.

## 6. Search for your favorite movie, TV show, actor, or director

- ☒ Once you're connected to the internet, you can easily search across top streaming channels and Antenna TV channels. Search by movie or TV show title, actor or director —all from one place. Search by typing words or phrases using the on -screen keyboard or on your mobile device or , *only in the United States* , speak words or phrases in a conversational tone using Voice Search . Some channels and content require payment .

## 7. Pause live TV

- ☒ Pause, resume, fast forward, and rewind TV shows. Simply connect your own USB drive with 16GB or bigger capacity to the TV and pause live TV for up to 90 minutes.

**Note:** *Live TV Pause is available on digital TV shows received on the Antenna TV input, and only when the TV is linked to a valid Roku account.*

## 8. Control your TV with voice commands

- ☒ *Only in the United States* , use your Roku Voice Remote (select models), Enhanced Voice Remote (select models) , or the free Roku mobile app to control your Roku TV. Use conversational voice commands to search for programs by title, actor, director, or genre. Also use voice commands to launch streaming channels , switch inputs, change Antenna TV channels, or open the Smart Guide .

## 9. Send your personal media to the big screen

- ☒ Send personal photos, videos, and music from your compatible smartphone or tablet to the TV screen in just a few taps. Plus, with certain channels, such as Netflix and YouTube , you can send movies, shows, sport highlights, and more directly to your TV .

## 10. Follow movies coming soon

- ☒ Use My Feed to choose from and follow a list of upcoming movies, and then watch for alerts each time one of your followed movies becomes available or changes price.

## 11. Take charge with a smartphone or tablet

- ☒ Control your TV with the included remote or from your compatible smartphone or tablet with the free mobile app for iOS<sup>®</sup> and Android<sup>™</sup> mobile devices\*. Browse channels, view My Feed, listen to audio from Antenna TV and streaming channels. Search more easily using a your mobile device's keyboard and , *only in the United States* , Voice Search .
- ☒ Mirror your compatible smartphone or tablet on your TV. Share videos, photos, web pages, and more from compatible devices.

## 12. Connect your Roku TV to networks found in hotels and college dorms

- ☒ You can temporarily link the TV to your smartphone or tablet to agree to any terms, enter codes, or provide required information before you can get Internet access .

**Note:** *Using your Roku TV on a restricted public network requires wireless availability and use of your network -connected smartphone, tablet, or computer to authenticate access to your account. You must use your Roku TV remote to initiate the connection process. Streaming content might be limited due to your geographic location or because of restrictions imposed by the network host.*

Go to [support.roku.com](http://support.roku.com) for device compatibility information .

**Let's get started.**

---

\* *IOS<sup>®</sup> is a trademark or registered trademark of Cisco in the U.S. and other countries and Android<sup>™</sup> is a trademark of Google Inc.*

*is used under license.*

# Connections and setup

## Main features

- wide screen for a complete home theater experience
- Super slim LCD TV with LED backlight
- 3840x2160 native resolution for HD performance
- Integrated ATSC TV tuner for HDTV broadcast reception
- HDMI inputs for true digital connections

## Accessories

|                              |   |
|------------------------------|---|
| Infrared Remote Control..... | 1 |
| User's Manual.....           | 1 |
| Battery (AAA).....           | 2 |

## Specifications

|   |  |                               |                               |
|---|--|-------------------------------|-------------------------------|
| Viewing Picture Size(diagonal)                    | 50" class<br>(49.5" diagonal)              | 58" class<br>(57.5" diagonal) | 65" class<br>(64.5" diagonal) |
| Resolution:                                       | 3840x2160                                  |                               |                               |
| Aspect Ratio:                                     | 16:9                                       |                               |                               |
| TV System:  | ATSC Digital system and NTSC Analog system |                               |                               |
| Video Signal System :                             | NTSC                                       |                               |                               |
| Receiving Channel :                               | Cable: 1-135/Air: 2-69(ATV&DTV)            |                               |                               |
| Maximum Power Consumption:                        | 138W                                       | 150W                          | 220W                          |
| Input Power Voltage:                              | 100-240V ~ 50/60Hz                         |                               |                               |
| Audio Output Power (THD ≤ 7%)                     | 2x10W                                      |                               |                               |
| High-Definition Multimedia Interface (HDMI) Input | x3   |                               |                               |
| Composite Video Input                             | x1   |                               |                               |
| Audio Input                                       | x1   |                               |                               |
| Headphone Output                                  | x1   |                               |                               |
| Optical Output                                    | x1   |                               |                               |
| USB 2.0 Input                                     | x1   |                               |                               |
| LAN Input   | x1   |                               |                               |

This product is manufactured, distributed, serviced and warranted exclusively by SHENZHEN MTC CO., LTD..  
 JVC is the trademark of JVC KENWOOD Corporation, used by such company under license.

# Front panel

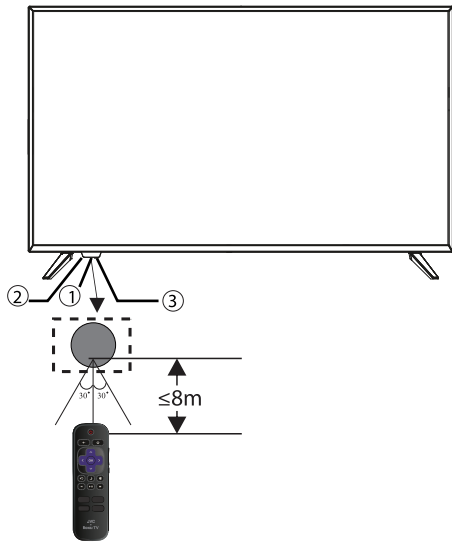

- 1: Remote control sensor.
- 2: Indicator LED: RED STANDBY.
- 3: Power / Input button

## Rear Connections



All the terminals are (from left to right):  
RF, USB, OPTICAL OUTPUT, RESET.

## SIDE Connections



All the terminals are (from left to right):  
LAN INPUT, VIDEO INPUT, AUDIO INPUT, HDMI3, HDMI2, HDMI1(ARC), HEADPHONE OUTPUT.

# INSTALLATION

## Antenna

Check to ensure that you have selected the right cables for the ports and that they are connected securely. Loose connections can affect the quality of the picture image and color. (Cables and External Equipment not included.)

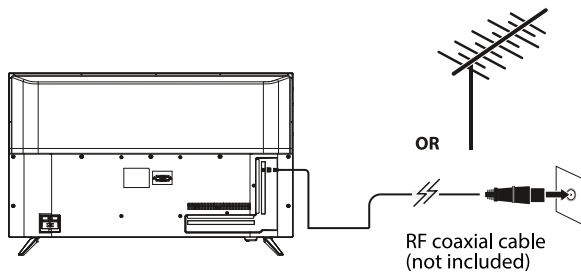

Note:

Aerial connections : F connector.

Input impedance : 75  $\Omega$  unbalanced.

With the tuner built-in you can connect your TV to an antenna and enjoy over-the-air entertainment.

1. When the setup wizard is complete select the Antenna TV icon from the  screen.
2. Follow the on-screen instructions.
3. Whenever you want to watch antenna TV, select the Antenna icon.

Plug in and turn on TV

Connect your power cord to the TV, then plug it into the wall outlet.

Press the power button on your TV remote control.

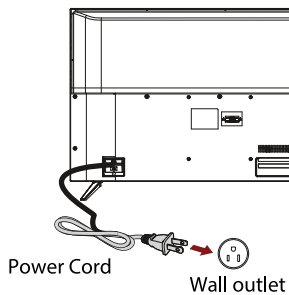

## Power connection

Please note: After unpackint, allow the TV to reach ambient room temperature before connection the TV to the mains power socket.

## PRESET MODE(HDMI)

|   | RESOLUTION | V.Freq.(Hz) | H.Freq.(KHz) |
|---|------------|-------------|--------------|
| 1 | 800*600    | 60          | 37.88        |
| 2 | 1024*768   | 60          | 48.36        |
| 3 | 1366*768   | 60          | 47.7         |
| 4 | 1280*768   | 60          | 47.3         |
| 5 | 1920*1080  | 60          | 67.5         |
| 6 | 3840*2160  | 60          | 67.5         |
| 7 | 3840*2160  | 60          | 112.5        |
| 8 | 3840*2160  | 60          | 135          |

## CABLE

When shipped from the factory, the Signal Type option is for the RF connector(F-type) set to the "AIR" (Over-the air antenna) mode.



# Base Stand Assembly Instruction

It is recommended two people handle TVs and installation.

To prevent scratch or damage to the TV screen, place the TV on a soft, flat surface.

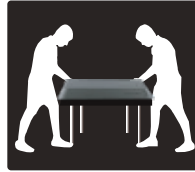

Attach the stands to the bottom of the TV by inserting the stand into slots on the TV. Secure the stand to the TV with the supplied screws.

To attach the left and right leg that forms the stand:

1. Place the legs into the bottom slots of the TV, insert and tighten the screws (found in the accessories bag) in the circled areas with the screwdriver (not provided).

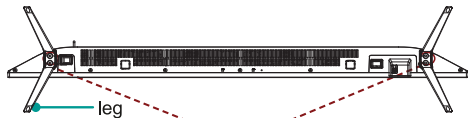

Screws

(50")



Screws

(58"/65")

2. After securing the stand, place the TV on a stable surface. The TV is ready for use now.

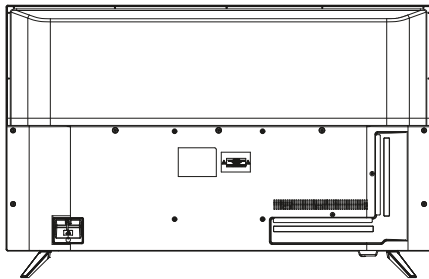

Note: TV cannot be wall mounted. Wall mount sold separately.

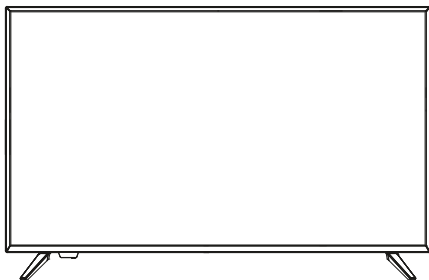

# External Connection

## AV Equipment

You can use the rear input terminals as follows.

Video Equipment: VCR, Multi Disc Player, DVD Player, Camcorder, Video Game, etc.

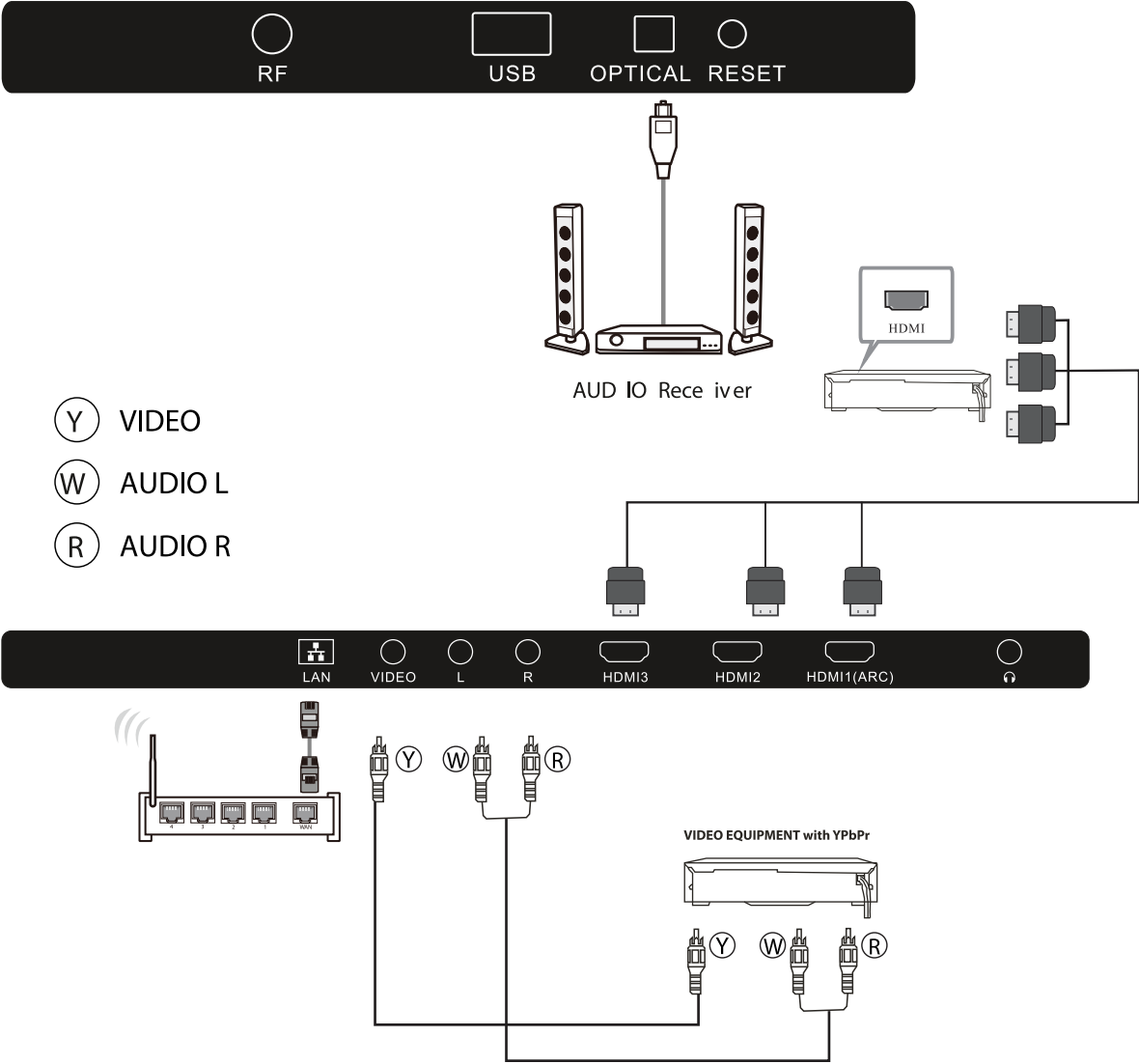

## External Connection

### Connecting a Camcorder

The rear panel jacks on your TV make it easy to connect a camcorder to your TV. They allow you to view the camcorder tape without using a VCR.

Each Camcorder has a different back panel configuration.

When connecting a Camcorder or DVD, match the color of the connection terminal to the cable.

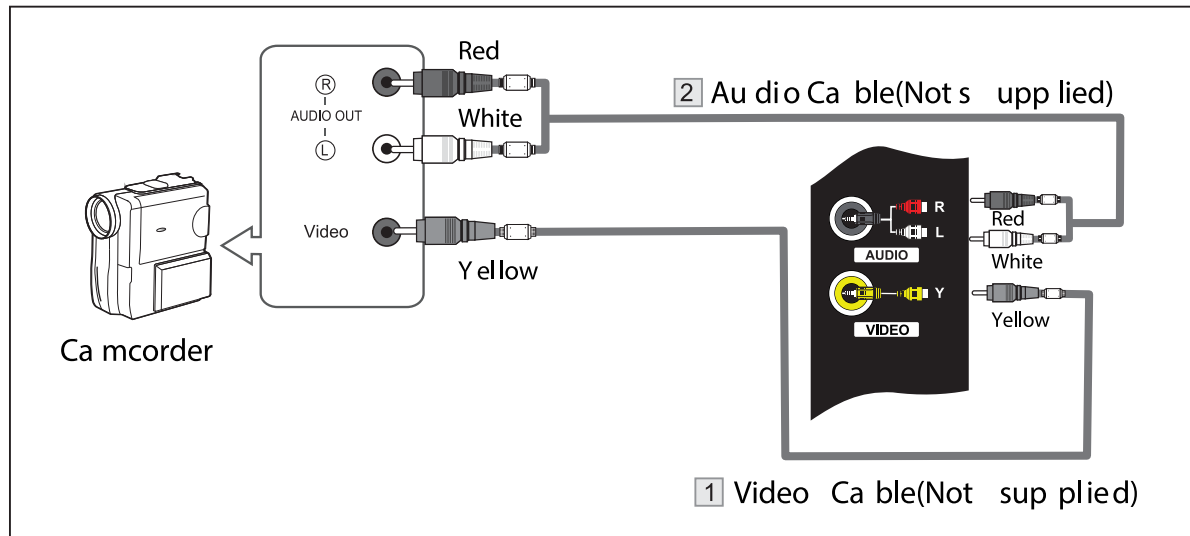

1. Connect a Video Cable between the A V VIDEO in jacks on the TV and the Video out jack on the camcorder.
2. Connect Audio Cables between the AUDIO L and AUDIO R jacks on the TV and the AUDIO out jacks on the camcorder.
3. Connect a Video Cable between the A V VIDEO in jacks on the TV and the Video out jack on the DVD.

#### Notes:

1. Whenever you connect an external device to your TV, make sure that power on the unit is turned off.
2. When connecting an external device, match the color of the connection terminal to the cable.

## External Connection

### Connecting Digital Audio System

This connection can only be made if there is a HDMI Output connector on the external device.

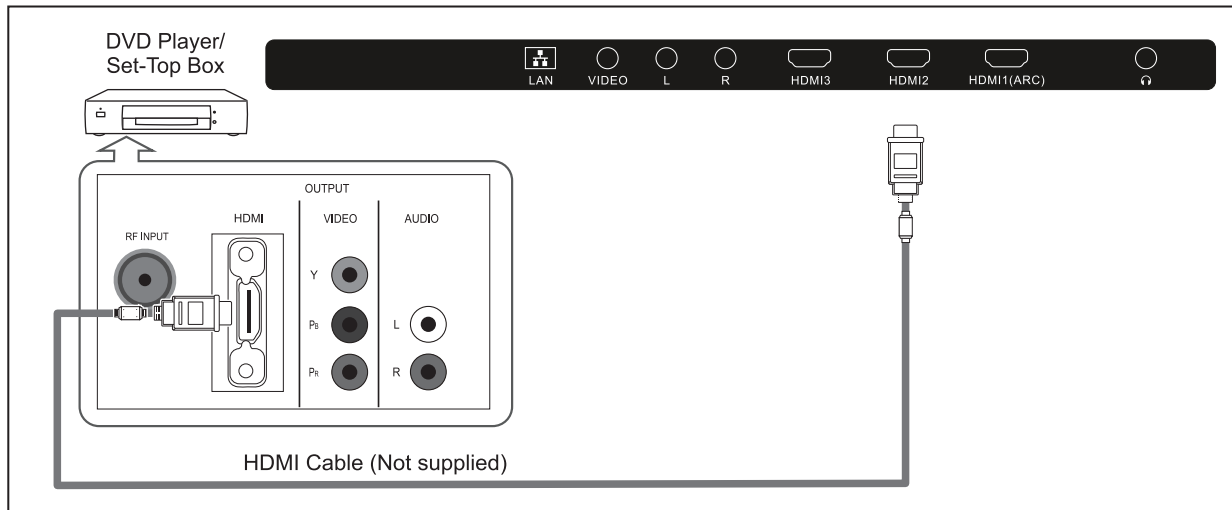

#### What is HDMI?

HDMI, or high-definition multimedia interface, is a next-generation interface that enables the transmission of digital audio and video signals using a single cable without compression.

Multimedia interface is a more accurate name for it especially because it allows multiple channels of digital audio.

The difference between HDMI and DVI is that the HDMI device is smaller in size, has the HDCP(High Bandwidth Digital Copy Protection) coding feature installed, and supports multi-channel digital audio.

Each DVD player/STB has a different back panel configuration.

Connect an HDMI Cable between the HDMI1, HDMI2, HDMI3 connector on the TV and the HDMI connector on the DVD player/Set-Top Box.

#### Notes:

1. Whenever you connect an external device to your TV, make sure that power on the unit is turned off.
2. When connecting an external device, match the color of the connection terminal to the cable.

# External Connection

## Connecting PC

The rear panel jacks on your TV make it easy to connect a Digital Audio System to your TV.

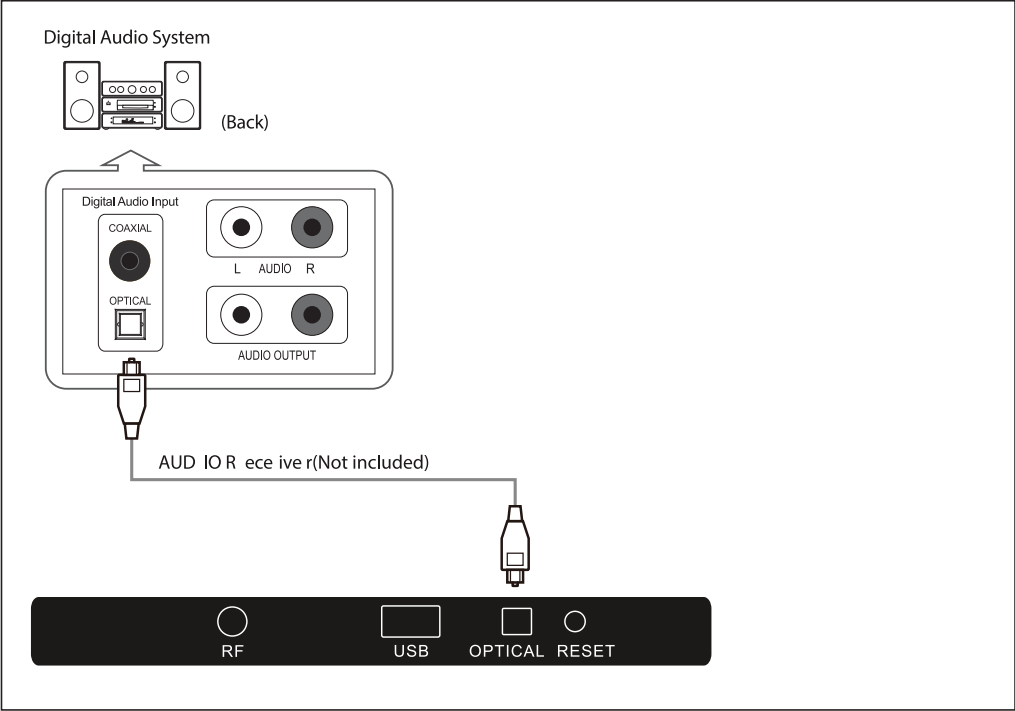

5.1 CH audio is possible when the TV is connected to an external device supporting 5.1 CH.

Connect an OPTICAL Cable between the OPTICAL jacks on the TV and the Digital Audio Input jacks on the Digital Audio System. When a Digital Audio System is connected to the OPTICAL terminal: Decrease the gain (volume) of the tv, and adjust the volume level with the Digital Audio System's volume control.

### Supporting Signals

| Input   | Mode |
|---------|------|
| Digital | ATSC |
| Analog  | NTSC |
| CVBS    | NTSC |

| Input | Resolution | Vertical Frequency  |
|-------|------------|---------------------|
| HDMI  | 720p       | 50Hz/60Hz           |
|       | 1080i      | 50Hz/60Hz           |
|       | 1080p      | 50Hz/60Hz           |
|       | 3840x2160  | 24Hz/25Hz/30Hz/60Hz |

## Wall Mount

### Instruction for Wall Mount

A wall mount kit(purchased separately) would allow you to mount your JVC TV on the wall. For detailed information on installing the wall mount, refer to the instructions provided by the wall mount manufacturer. It is strongly recommended to contact a technician for professional assistance for wall mount installation. JVC is not responsible for any damage to the product or injury to yourself or others resulting from the wall-mounting.

Dimensions for Mounting Hole Pattern

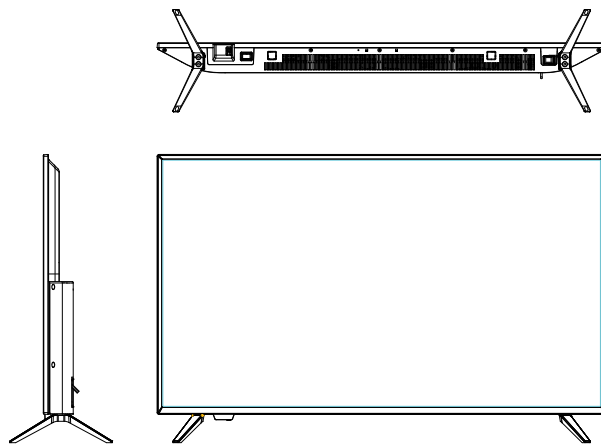

This JVC TV is compatible with a mounting hole pattern(50": 200mm x 200mm; 58"/65": 400mm x 200mm ).

- 4 pcs of type M6 screws are required for installing the wall mount bracket to your JVC TV. Do not use screws that are longer than 12mm. Screws that are too long may cause damage to the inside of the TV set.
- Do not fasten the screws too tight for this may damage the TV or cause the TV to fall, resulting in personal injury. JVC is not liable for these kinds of incidents.
- Do not mount your JVC TV at more than a 15 degree tilt.
- Always use two people to mount the TV to a wall.
- Do not install your Wall Mount Kit while your TV is turned on. It may result in personal injury due to electric shock.

Refer to your TV's Quick Start Guide or other provided documentation to for model-specific information about attaching the base or a wall mount and making connections to AC power and to your other audio/video devices . The following information applies to all Roku TV models.

## Connecting an antenna, cable, or satellite box

If you are using an antenna, CATV cable without a set top box, or a cable or satellite box that has only an antenna output, connect a 75 ohm coaxial cable (not provided) from the device to the ANT/CABLE input on the TV .

**Tip:** *If you are using an antenna with a 300 ohm twin lead cable, you need to use a 300 -to-75 ohm adapter (not provided) to adapt the twin lead cable to a connection that is compatible with the TV 's antenna input.*

**Tip:** *If you receive your TV stations through a set top box from a cable or satellite TV provider, connect it to the TV using the best connection method available. From most to least desirable:*

- ☒ **HDMI® input** – Digital HD and SD video
- ☒ **AV input** – analog SD video
- ☒ **Antenna input** – analog SD video using NTSC

## Connecting external equipment with a composite AV video cable

If the best connection available on your device is AV or composite video output, connect it to the TV using a composite AV cable (not provided). Composite AV cables typically have three RCA -type plugs on each end, color coded as follows:

- ☒ **Yellow** – Video
- ☒ **Red** – Audio, right channel
- ☒ **White or black** – Audio, left channel

Connect each plug to the corresponding connector on the device and on the TV .

**Note:** *Select models have an AV Input that looks like a headphone jack. Use the breakout cable (included) to adapt this input to the three RCA -type plugs on your composite cable.*

## Connecting external equipment with an HDMI<sup>®</sup> cable

If possible, connect your devices using HDMI<sup>®</sup> cables (not provided) . They help to provide the best video quality and also carry audio signals, so that only one cable is needed. For better picture quality, we recommend that you use cables designated as High Speed HDMI<sup>®</sup> Cables.

**Tip:** *You might need to configure the device to send its signal through its HDMI<sup>®</sup> connector.*

The connector labeled **HDMI IN (ARC)** has the additional ability to use the audio return channel to send digital audio to a receiver or sound bar, as explained in [Connecting an AV receiver or digital sound bar](#) .



## Connecting headphones or analog sound bar to the TV

You can connect headphones or an analog sound bar (not provided) to the TV's headphone jack.

**Tip:** *Inserting a plug in the headphone jack disables the sound from the TV's built-in speakers.*

**Warning:** *Loud noise can damage your hearing. When using headphones, use the lowest volume setting on your headphones that still lets you hear the sound.*

Select models also have an audio line out connection that is not affected by TV volume or mute settings and does not disable the TV speakers. Use this connection when you want to use your amplifier or sound bar to control the TV volume. To turn off the TV's built-in speakers, in the Home screen menu, navigate to **Settings > Audio > TV speakers** and change the setting.

## Connecting headphones to the Roku Enhanced Voice Remote

Select Roku TVs come with the Roku Enhanced Voice Remote. On these models, you can connect headphones to the jack on the left side of the remote.

**Tip:** *Inserting a plug in the remote's headphone jack disables the sound from the TV's built-in speakers or attached receiver or sound bar. The volume and mute controls on the right side of the remote adjust the volume level of the connected headphones.*

**Warning:** *Loud noise can damage your hearing. When using headphones, use the lowest volume setting on your headphones that still lets you hear the sound. You might notice that connecting headphones to your remote shortens the remote's battery life somewhat.*

## Connecting an AV receiver or digital sound bar

You can enjoy Dolby Digital Audio™ multichannel sound from your TV if you connect a digital amplifier or sound bar (not provided) in either of two ways:

- ⊗ **Digital optical audio out (S/PDIF)** – Connect a TOSLINK optical cable (not provided) from the TV to the Optical input on your receiver or sound bar.
- ⊗ **HDMI® ARC** – Connect an HDMI® cable (not provided) from the **HDMI (ARC)** connector to the HDMI® input on your receiver or sound bar. This connection uses the Audio Return Channel (ARC) feature of the HDMI® specification to output sound from the TV to a compatible device. To use this feature, you must configure the TV to enable HDMI® ARC, as explained in [Enable HDMI® ARC](#).

## Preparing for Internet connectivity

If you want to watch streaming content and take advantage of the cool features of your Roku TV, connect it to the Internet through a wireless modem/router or a wireless access point (not provided). The TV has a built-in wireless LAN adapter.

**Note:** *The TV supports only its internal wireless network adapter —it does not support the use of a USB network adapter.*

Select 4K models have wired in addition to wireless network connectivity. To use the wired network connection, connect an RJ-45 Ethernet cable (not provided) from the jack on the back of your TV to your network router or switch. The wired connection supports both 10 Base-T and 100 Base-T Ethernet.

## AC power

Plug your TV into a power outlet. You can tell that the TV has power because the status indicator lights up when the TV is off.

The topic [Status indicator](#) explains how the status indicator shows what is happening with the TV.

## Roku remote batteries

Open the back of your Roku remote and insert the included batteries, observing the proper orientation as indicated in the battery compartment. Reattach the back cover.

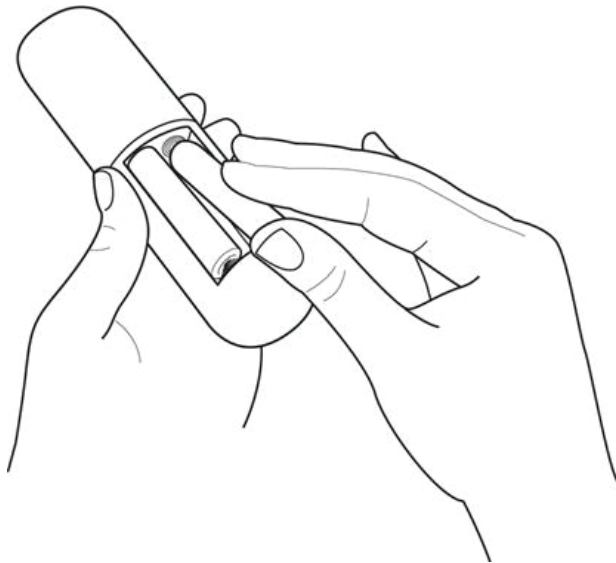



## Roku TV remote





Use the following information to identify the buttons on your Roku remote.

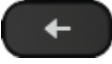

**Note:** *Certain remote buttons and features vary by model. Your remote might not have all buttons or features listed.*

- ☒ *If your remote has a microphone button  just below the purple pad, then you have a Roku Voice Remote.*
- ☒ *If your remote has a headphone jack on its left edge, then you have a Roku Enhanced Voice Remote.*

The Roku voice remotes have additional capabilities as described in the following table.

| BUTTON  | FUNCTION | DESCRIPTION  |
|---|----------|--|
|    | POWER    | Turns TV on and off.   |
|    | BACK     | <ul style="list-style-type: none"> <li>☒ Menu: Goes back to previous menu/screen.</li> <li>☒ Home screen tile: Moves highlight back to the Home screen option.</li> <li>☒ Watching Antenna TV or a TV input: Returns to Home screen.</li> <li>☒ Playing streaming content: Stops playing stream and returns to the previous menu or screen.</li> <li>☒ Browsing streaming content: Goes to the previous level in the content tree.</li> </ul>  |
|    | HOME     | Immediately returns to the Home screen.  |
|  | PAD      | <ul style="list-style-type: none"> <li>☒ <b>LEFT/RIGHT/UP/DOWN</b> moves the highlight in the corresponding direction.</li> <li>☒ <b>OK</b> selects the highlighted option.</li> </ul> <p>While watching TV:</p> <ul style="list-style-type: none"> <li>☒ <b>UP/DOWN</b> changes channel.</li> <li>☒ <b>LEFT</b> displays the Smart Guide (connected mode) or channel list (non-connected mode).</li> <li>☒ <b>LEFT/RIGHT</b> only on TVs operating in non-connected mode, while in the channel list switches between All Channels and FAVORITE CHANNELS.</li> <li>☒ <b>OK</b> while in the channel list selects the highlighted channel.</li> </ul> <p>While watching live TV: displays the program information banner.</p> |

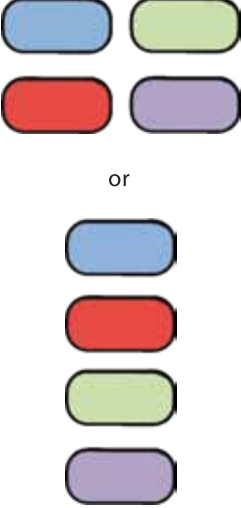
| BUTTON  | FUNCTION                        | DESCRIPTION  |
|---|---------------------------------|--|
|    | VOICE SEARCH and VOICE COMMANDS | <p><i>Only in the United States on select models with Roku voice remotes</i> . Hold and say the name of a movie, TV show, actor, or director to search across many streaming and Antenna TV channels . Say a command to start streaming, change a channel, and more. For more information, go to:</p> <p><a href="http://go.roku.com/voicesearch">go.roku.com/voicesearch</a></p>  |
|    | GAME MODE                       | <p><i>Select models</i> . Displays a banner showing the current Game mode or <b>Not available at this time</b>. Subsequent presses toggle Game mode. When <b>On</b>, the TV performs less image processing and has less input lag, producing a better experience with action games. <i>Available only for HDMI and AV inputs.</i></p>  |
|    | INSTANT REPLAY                  | <p><i>Select models</i> . Streaming programs that support this feature and Antenna TV channels : if Live TV Pause is enabled, jumps back a few seconds with each press and resumes playing.</p> <p>Broadcast TV : If Live TV Pause is disabled, jumps to previous channel.</p> <p>When using an on-screen keyboard : Backspaces in the text you are entering.</p> <p>Smart Guide: Returns to the current day and time.</p>                                       |
|  | SLEEP                           | <p><i>Select models</i> . Displays a banner showing the remaining sleep time, if any, or <b>Sleep timer is off</b>. Subsequent presses cycle among the preset sleep time intervals. Once set, the sleep timer remains in effect regardless of what you are watching.</p>   |
|  | MEDIA PLAYBACK CONTROLS         | <p>Rewind, pause, play, and fast forward streaming content and Antenna TV channels (if Live TV Pause is enabled).</p> <p>Press <b>REWIND</b> or <b>FAST FORWARD</b> one, two, or three times to control the speed of the operation.</p> <p><b>REWIND</b> and <b>FAST FORWARD</b> also jump backward and forward one page at a time when viewing long lists, such as when you are browsing Antenna TV shows in the channel list or Smart Guide (U. S. only) .</p> |

| BUTTON  | FUNCTION                | DESCRIPTION  |
|---|-------------------------|--|
|    | OPTIONS                 | Displays additional options when available. On -screen hints let you know when this button is active.  |
|    | PRESET CHANNEL SHORTCUT | Dedicated buttons show the logo of a preset streaming content provider. Dedicated content providers vary by model and region. Pressing a button: <ul style="list-style-type: none"> <li>☒ Displays the streaming channel's main page if you have already added the channel to your Home screen.</li> <li>☒ Displays the streaming channel's sign-up page if you have not already added the channel.</li> </ul> |
|   | VOLUME/MUTE             | Located on the right edge of the remote. Increases/decreases volume and mutes the TV sound. <p><b>Note:</b> <i>If the TV is muted, pressing <b>VOLUME UP</b> unmutes. Pressing <b>VOLUME DOWN</b> does not unmute the sound.</i></p>   |
|  | HEADPHONE               | <i>Select models with Roku Enhanced Voice Remote .</i> Connect headphones to the jack on the left edge of the remote to listen privately. Plugging in headphones mutes the TV speakers.  |

# Panel buttons

Your TV has a set of panel buttons that perform simple control functions. The TV panel buttons are not a substitute for the remote, as they do not give you access to all TV functions.

Depending on model, your TV model has one of several different panel button designs. Choose the one that applies to your TV from the following list:

- [Single button](#)
- [Three buttons](#)
- [Game -pad style joystick](#)
- [Four buttons](#)
- [Five buttons \(with mute\)](#)
- [Five buttons \(without mute\)](#)
- [Seven buttons](#)

## Single button

If your TV has this style of panel button, you can perform the following functions:

- Turn TV on:** short press .
- Display the Input List:** short press when TV is on .
- Select the next input in the Input List:** short press while the TV is showing the Input List .
- Dismiss the Input List without changing inputs:** no press .
- Turn TV off:** long press .

Short press = less than two seconds

Long press = more than two seconds

No press: = no press within two seconds

## Three buttons

If your TV has this style of panel buttons, you can perform the following functions:

- ☒ **Turn TV on:** middle button, short or long press .
- ☒ **Volume up:** right button when Input List is not active .
- ☒ **Volume down:** left button when Input List is not active .
- ☒ **Display Input List:** middle button, short press when TV is on .
- ☒ **Highlight next input in the Input List:** right button when Input List is active .
- ☒ **Highlight previous input in the Input List:** left button when Input List is active .
- ☒ **Select highlighted item in the Input List:** middle button, short press, or no press .
- ☒ **Turn TV off:** middle button, long press .

Short press = less than two seconds

Long press = more than two seconds

No press: = no press within four seconds

## Game-pad style joystick

If your TV has this style of panel button, you can perform the following functions:



- ☒ **Press in:** Toggle between power ON and Standby .
- ☒ **Press up or down:** Increase /decrease the volume .
- ☒ **Press left or right:** Switch inputs . Each press moves the highlight up or down one item. Pausing for a few moments selects the highlighted item.

## Four buttons

If your TV has this style of panel buttons, you can perform the following functions:

- ☒ **Power:** Turns the power on and off.
- ☒ **Input:** Selects among TV inputs. Each press moves down one item. Pausing for a few moments selects the highlighted item.
- ☒ **Volume +:** Increases the volume.
- ☒ **Volume -:** Decreases the volume.



## Five buttons (with mute)

If your TV has this style of panel buttons, you can perform the following functions. Note that the order of the buttons might vary from model to model. Examine the panel button labels to determine your TV model's layout.

- ☒ **Power:** Turns the power on and off.
- ☒ **Input:** Selects among TV inputs. Each press moves down one item. Pausing for a few moments selects the highlighted item.
- ☒ **Volume +:** Increases the volume.
- ☒ **Volume -:** Decreases the volume.
- ☒ **Mute:** Mutes and unmutes the sound.

## Five buttons (without mute)

If your TV has this style of panel buttons, you can perform the following functions. Note that the order of the buttons might vary from model to model. Examine the panel button labels to determine your TV model's layout.

- ☒ **Power:** Turns the power on and off.
- ☒ **Input +:** Selects the next TV input. Each press moves down one item. Pausing for a few moments selects the highlighted item.
- ☒ **Input -:** Selects the previous TV input. Each press moves up one item. Pausing for a few moments selects the highlighted item.
- ☒ **Volume +:** Increases the volume.
- ☒ **Volume -:** Decreases the volume.

## Seven buttons

If your TV has this style of panel buttons, you can perform the following functions. Note that the order of the buttons might vary from model to model. Examine the panel button labels to determine your TV model's layout.

- ☒ **Input:** Selects among TV inputs. Each press moves down one item. Pressing **Channel +** or **Channel -** moves the highlight up or down. Pausing for a few moments selects the highlighted item.
- ☒ **Channel +:** Moves the highlighted item up in the current menu.
- ☒ **Channel -:** Moves the highlighted item down in the current menu.
- ☒ **Volume +:** Increases the volume.
- ☒ **Volume -:** Decreases the volume.
- ☒ **Mute:** Mutes and unmutes the sound.
- ☒ **Power:** Turns the power on and off.

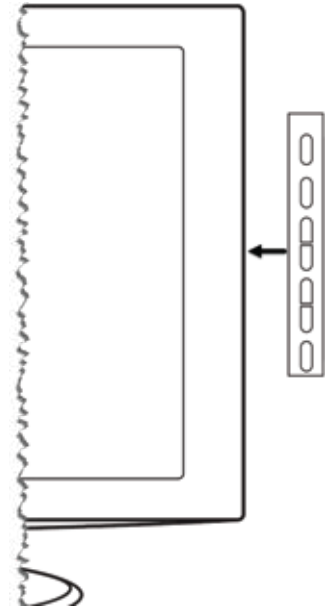

# Guided Setup

With the preliminaries out of the way, it's time to turn on your TV. As the TV starts for the first time, it leads you through Guided Setup, which configures the TV before you start to use it.

During Guided Setup, you'll:

- ☒ Answer a few questions
- ☒ Provide network connection information
- ☒ Get a software update
- ☒ Link your TV to your Roku account.
- ☒ Connect devices such as a DVD player, game console, or cable box.

## Starting Guided Setup

To start Guided Setup, press the **POWER** button on the remote to turn on your TV.

**Note:** *Guided Setup normally runs only once, the first time you turn on your TV. If you need to run Guided Setup again, you'll have to perform a factory reset, as explained in [Factory reset everything](#).*

When you first turn on your TV, it will take a few seconds to get itself ready. You'll notice the following things happening:

1. The status indicator blinks every time the TV is busy doing something; in this case it's powering up and getting ready for you.
2. The power-on screen appears and the status indicator blinks slowly for a few more seconds. The power-on screen shows a brand logo while the TV starts up.
3. After a few seconds, Guided Setup starts.

# Completing Guided Setup

Follow these steps to complete Guided Setup. At this point, you should be seeing the **Language** screen.



1. *Only on models that have a Roku voice remote* : A few moments after the **Let's get started screen** appears, Guided Setup starts the pairing process for the voice remote. (You'll know if you have this type of remote because it will have microphone or search button just below the down arrow on the purple pad.) If the voice remote does not pair automatically, follow the instructions on the screen to complete the pairing process.

**Tip:** *On TVs sold in the United States, if you are blind or visually impaired, you can activate Audio Guide, a text-to-speech screen reader to help you navigate the TV's menus and commands. To enable the Audio Guide, press the \* button on the remote four times in rapid succession. Repeat to disable Audio Guide. (The \* button is located directly below the directional pad on the right side of the Roku remote.)*

**Note:** *If you enabled Audio Guide, choosing any language other than English disables it.*

2. Press the **DOWN** arrow on the remote to highlight your preferred language, and then press **OK** or the **RIGHT** arrow.

3. *Some models have a country selection screen* : If you don't see this screen, skip ahead to the next step. If you see this screen, select your country.



**Note:** *If you enabled Audio Guide, choosing any country other than United States disables it.*

4. Press **OK** or the **RIGHT** arrow on the remote to go to the next screen :

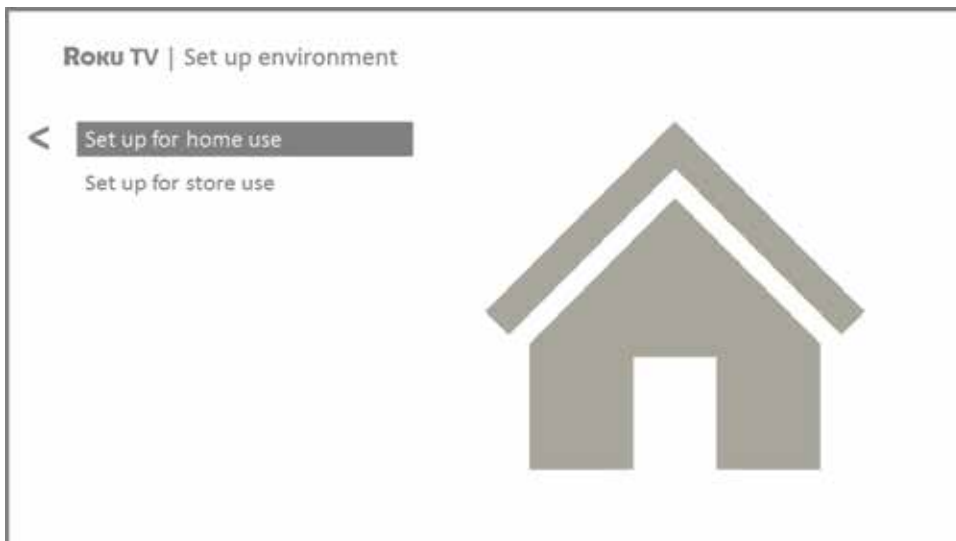

**Note:** *Some models show the title **First things first** instead of **Set up environment**.*

5. Press **OK** to select **Set up for home use**. This is the right choice for enjoying your TV at home. It provides energy saving options as well as access to all features of the TV.

**Note:** *Store mode configures the TV for retail display and is not recommended for any other use. In store mode, some features of the TV are missing or limited. To switch from one mode to the other, you have to perform a factory reset as explained in [Factory reset everything](#), and then repeat Guided Set up.*

## Network connection

After you select **Set up for home use**, the TV prompts you to make a network connection. If your TV has both wired and wireless connections, you'll see the following screen.

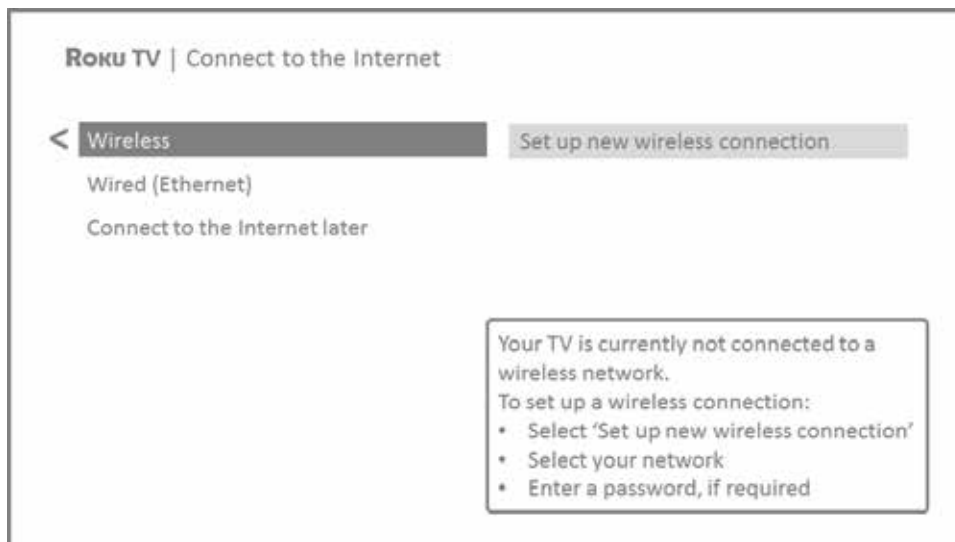

6. *Only models that display the **Connect to the Internet** screen:* Make a selection:

- ☒ **Wireless connection** – Highlight **Set up new wireless connection** and press **OK**. The TV prompts you through wireless setup. Skip ahead to the next step for help with the process.
- ☒ **Wired connection** – Highlight **Connect to wired network** and press **OK**. The TV immediately attempts to connect to your wired network, your local network, and then the Internet. Go to Step 9 to continue with Guided Setup.
- ☒ **Connect to the Internet later** – If you don't want to connect to the Internet right now, you can skip this step and use the TV to watch Antenna TV channels, play games, and watch DVDs. When you're ready to connect, it's easy. We'll show you how in [Benefits of connecting](#).

**Note:** *If you decide not to connect, Guided Setup skips ahead to setting up the devices that you've connected to your TV. Jump ahead to [Connect your devices](#) to complete Guided Setup.*

7. *On models that have wireless only, or models with both wired and wireless and you've selected **Wireless**:* The TV scans for the wireless networks within range and displays them in order, with the strongest signals first. In addition to your own wireless signal, the TV might pick up signals from your neighbors.



Press the **UP** or **DOWN** arrows to highlight the name of your wireless network, and then press **OK** to select it.

**Note:** Some networks, such as those often found in dorm rooms, hotels, and other public places, require you to read and agree to terms, enter a code, or provide identifying information before letting you connect to the Internet. If your Roku TV detects that you are connecting to such a network, it prompts you through the connection process using your compatible smartphone or tablet to provide the needed information. For more information, see [Using your TV in a hotel or dorm room](#).

## Other options

- ☒ **Connect to the Internet later** – If you don't want to connect to the Internet right now, you can skip this step and use the TV to watch Antenna TV channels, play games, and watch DVDs. When you're ready to connect, it's easy. We'll show you how in [Benefits of connecting](#).

**Note:** If you decide not to connect, Guided Setup skips ahead to setting up the devices that you've connected to your TV. Jump ahead to [Connect your devices](#) to continue.

- ☒ **Scan again / Scan again to see all networks** – The name of this option depends on the number of wireless networks within range.
  - **Scan again** appears if the list already shows all available wireless networks within range. If you don't see your wireless network name in the list, you might need to adjust the location of your wireless router or the TV, turn on your router, or make other changes. When everything is ready, select **Scan again** to see if your network name now appears in the list.
  - **Scan again to see all networks** appears if there are more wireless networks than the strongest ones it initially listed. If you don't see your wireless network name in the list, this option displays the complete list. If you still don't see your network name, you might have your router configured to provide wireless service as a "private network."

**Note:** Highlighting either of these options displays an informational panel with the unique media access control (MAC) address of your Roku TV. You will need the MAC address if your wireless router is configured to use MAC address filtering.



- ☒ **Private network** – If your wireless network name is hidden, it won't appear in the list. Select **Private network** to display an on-screen keyboard, and use it to enter your network name. Unless you changed the factory -set network name, you can find the name (also called SSID) on a label on the router.

**Tip:** *Wireless networks that are password-protected display a “padlock” icon adjacent to the name. This icon enables you to know that you are going to be prompted to enter a password after you select that network.*



8. *Only if you select a password protected wireless network* : An on-screen keyboard appears. Use the keyboard to enter the network password .



After you submit your wireless network password, the TV displays progress messages as it connects to your wireless network, your local network, and the Internet.

9. Only if your TV cannot get the correct time zone and current time from your network service provider : Use the **UP** and **DOWN** arrow s to highlight your time zone, and then press **OK**.

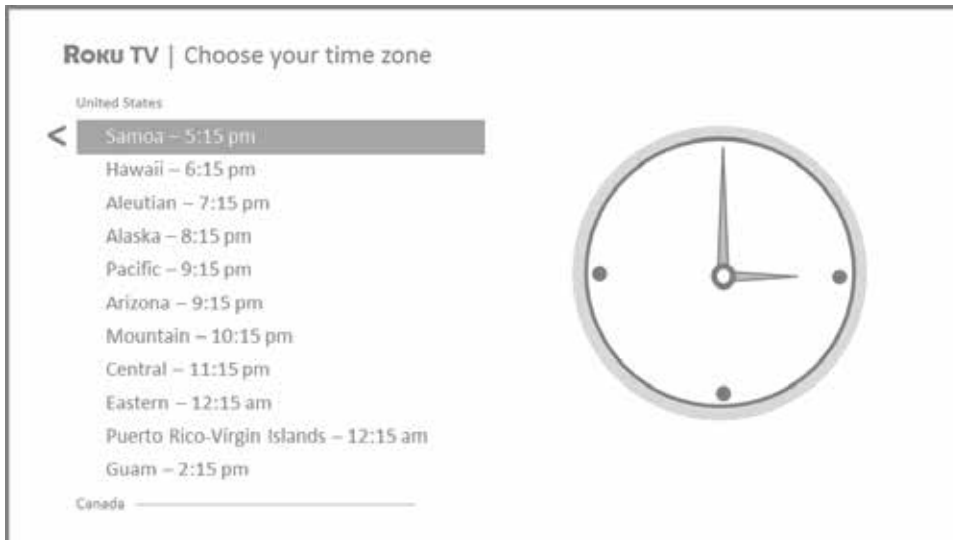

**Tip:** Your TV needs to know the local time zone so that it can correctly display information about the program you are currently watching. If the TV is unable to automatically determine the local time zone, it prompts you to choose your time zone from a list.

As soon as the TV is able to connect to the Internet, it downloads and installs its first software update, and then restarts.

**Tip:** Your TV automatically checks for updates periodically. These updates provide new features and improve your overall experience with the TV. After an update, you might notice that some Options have moved, and that there are new options or features. This User Guide describes version 8.0 . To determine your current Roku TV software version, go to **Settings > System > About** after you complete Guided Setup. You can download an updated User Guide that matches your Roku TV software version from the Roku TV web site .

## Activation

After the TV restarts, it displays the **Activation** screen:



10. Using a compatible computer, tablet, or smartphone with an Internet connection, go to the web address displayed on the screen and enter the code that appears on your screen.

---

### Why do I need a Roku account?

You need a Roku account for several reasons:

- ☒ It links you, your Roku TV, and your other Roku streaming devices to the Roku Channel Store and billing service.
- ☒ Streaming content providers know that it's OK to send content you request to your Roku TV.
- ☒ Roku can automatically send updates to your device.

You need a Roku account to activate your device and access entertainment across thousands of streaming channels. Roku accounts are free, and while a valid credit card number is not required to create your account, providing your credit card information makes renting and purchasing entertainment from the Roku Channel Store fast and convenient.

---

After you log in or create your Roku account, the link page suggests that you select some streaming channels. After you confirm your selections, the TV gets an acknowledgement, and then adds your preexisting and newly -selected streaming channels to your Roku TV. This process is automatic and takes a few moments —a little longer if you already have a lot of streaming channels to add .

**Tip:** *Streaming channels from all Roku streaming devices associated with your account are synchronized periodically, so that all of your Roku streaming devices have the same set of streaming channels (subject to compatibility with the device).*

## Connect your devices

Next, Guided Setup helps you set up the external devices that you want to use with it , such as a cable box, Blu-ray™ player, or game console.

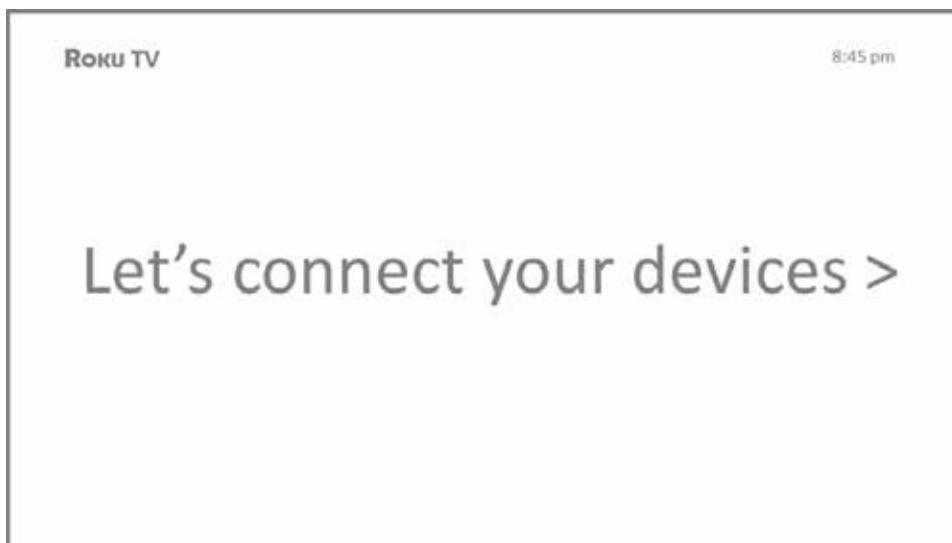

11. Press **OK** or the **RIGHT** arrow to proceed:



12. Connect all the devices you plan to use with your TV, turn them all on, and then select **Everything is plugged in and turned on**. The TV now takes you step by step through each of its inputs and asks what kind of device you have connected. On each input that has a connected and active device, you can see its picture and hear its sound.



13. Press the **UP** or **DOWN** arrows to highlight the label you want to associate with the input. If you are not using the input, select **Nothing**, and the input won't appear on the Home screen.

14. While setting up your devices, rather than using the predefined names and icons, you can set a custom name and icon. To do so, scroll up or down to highlight **Set custom name & icon**, and then press **OK**. Follow the instructions on the screen to enter a name and select an icon for the input. See [Rename inputs](#) for more information.

**Note:** *If you have renamed the inputs, you cannot use voice commands to switch inputs. Voice commands can only switch among inputs that have their original names, such as “AV,” and “HDMI 1.”*

15. Repeat the previous step for each input.

You're done with Guided Setup.

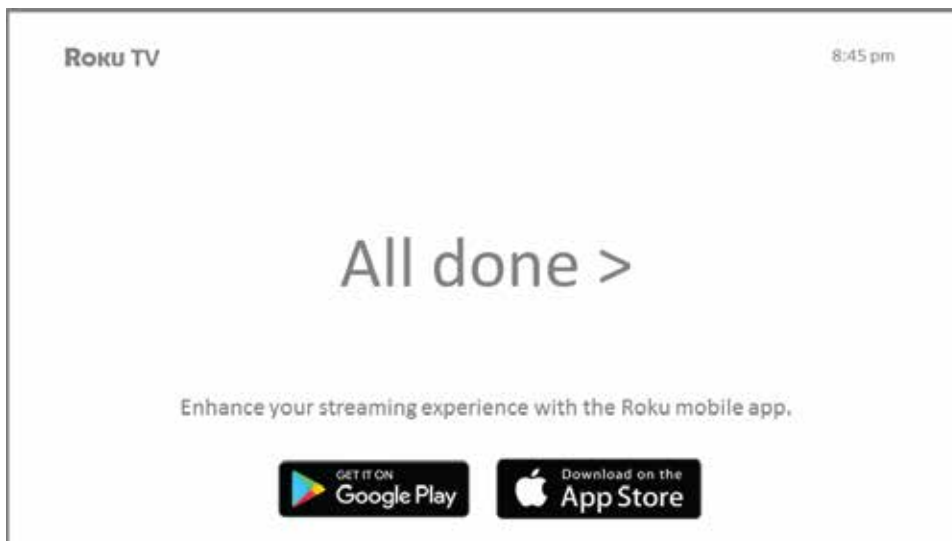

**Note:** *Some Roku TVs, depending on where you live and other factors, show you an introductory video filled with some great hints and tips. If you're not interested in viewing this video, press  on the remote to return to the Roku TV Home screen.*

Whenever you press  on the remote, the Home screen greets you.

From here, you can explore everything your TV has to offer. Press the arrow keys to move around, and press **OK** to select a highlighted item. We've designed the TV to encourage you to explore, and you can probably figure out most of the capabilities and settings on your own. If you have any questions or difficulties, you can find answers and solutions in this guide.

# Home screen

The following illustrations show typical Home screens, which vary depending on location, connected mode, selected theme, number of TV inputs enabled, and streaming channels and apps added.

**Note:** A paid subscription or other payments may be required for some channel content. Channel availability is subject to change and varies by country. Not all content is available in countries or regions where Roku products are sold.

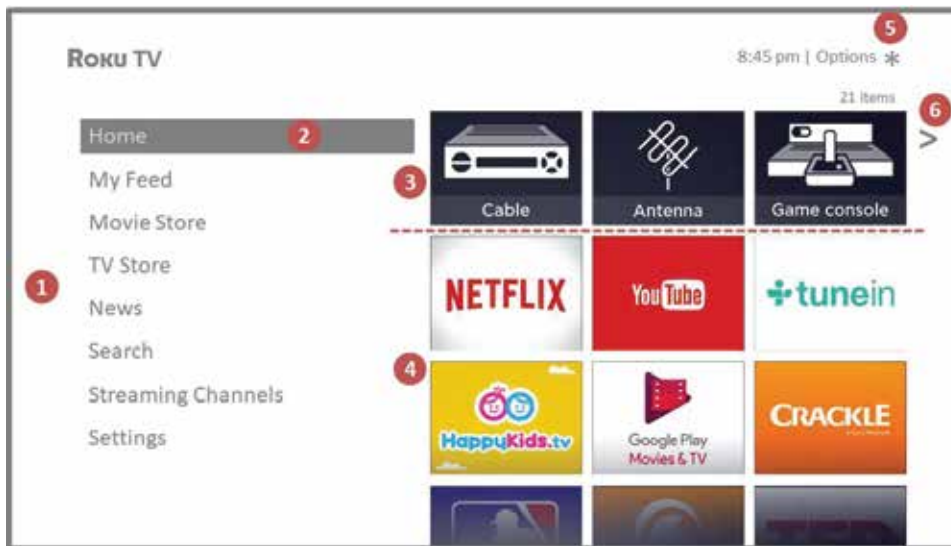

Typical connected Home screen, United States

1. Home screen menu —shows options available to you when you are on the Home screen.
2. Highlighted option —press **OK** on the remote to select.
3. TV input tiles —select an input to watch the connected device.
4. Streaming channel and app tiles —select a tile to go to the indicated streaming channel or application.
5. Options hint —press **\*** on the remote for options when this symbol is present.
6. Next screen hint —press the **RIGHT** arrow on the remote to see the next screen.

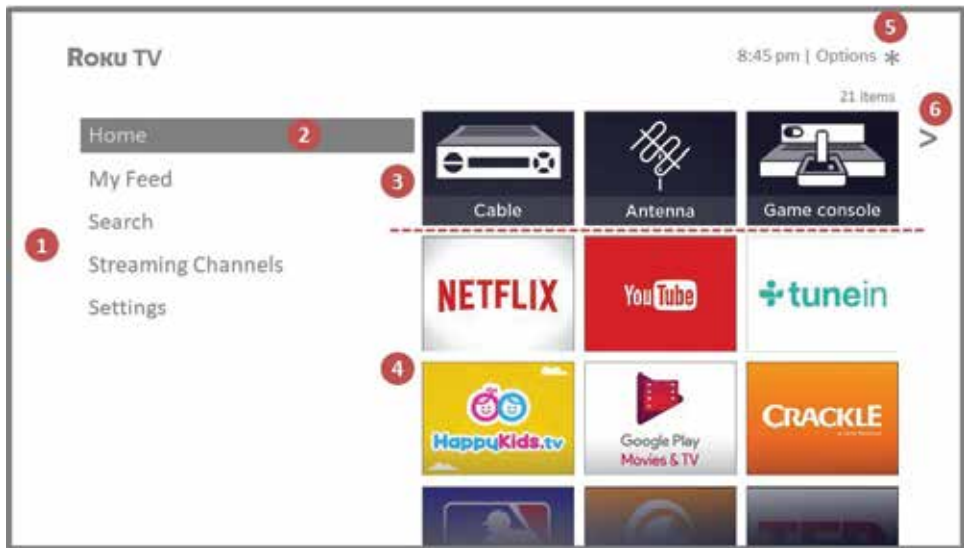

Typical connected Home screen, Canada

1. Home screen menu —shows options available to you when you are on the Home screen.
2. Highlighted option —press **OK** on the remote to select.
3. TV input tiles —select an input to watch the connected device.
4. Streaming channel and app tiles —select a tile to go to the indicated streaming channel or application.
5. Options hint —press **\*** on the remote for options when this symbol is present.
6. Next screen hint —press the **RIGHT** arrow on the remote to see the next screen.

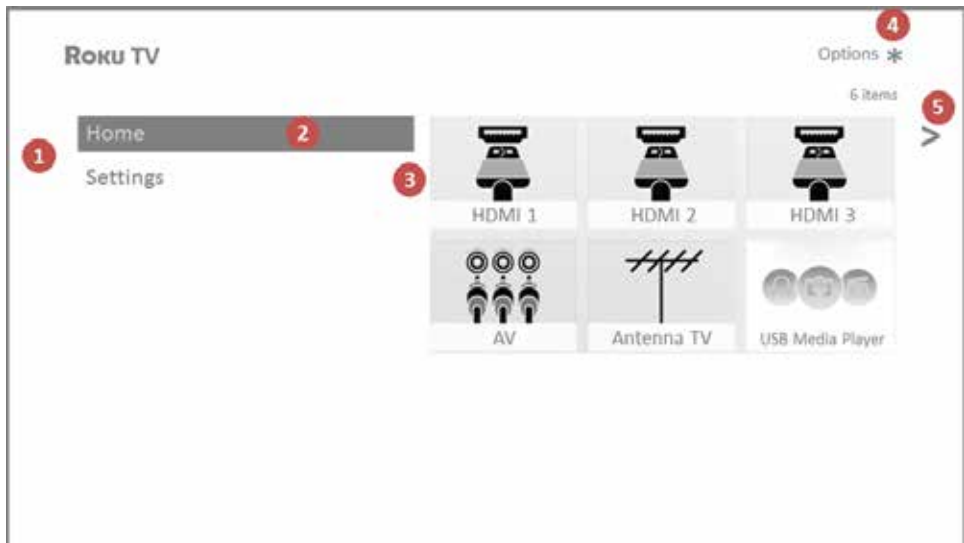

Typical non-connected Home screen

1. Home screen menu —shows options available to you when you are on the Home screen.
2. Highlighted option —press **OK** on the remote to select.
3. TV input tiles —select an input to watch the connected device.
4. Options hint —press **\*** on the remote for options when this symbol is present.
5. Next screen hint —press the **RIGHT** arrow on the remote to see the next screen.



## Personalize your Home screen

There are many things you can do to personalize your Home screen and make it just right for you and your family:

- ☒ *Only in connected mode* : Add streaming channels by using the **Streaming Channels** menu option to browse the Roku Channel Store.
- ☒ *Only in connected mode* : Change the screen theme by going to **Settings > Themes** to find and pick one to suit your mood.
- ☒ *Only in connected mode on U.S. models* : Hide Movie Store, TV Store, or News as explained in [Configure parental controls](#).
- ☒ Remove a tile by highlighting it and pressing **\***. Then highlight **Remove input** or **Remove channel** and press **OK**.
- ☒ Move a tile by highlighting it and pressing **\***. Then highlight **Move input** or **Move channel** and press **OK**. Use the arrow keys to move the tile, and then press **OK** to lock it in its new location.
- ☒ Rename a TV input tile by highlighting it and pressing **\***. Then highlight **Rename input** and press **OK**. Highlight a new name in the list, and then press **OK** to assign that name to the tile.

Rather than using the predefined names and icons, you can set a custom name and icon. To do so, scroll up or down to highlight **Set custom name & icon**, and then press **OK**. Follow the instructions on the screen to enter a name and select an icon for the input.

**Note:** *If you have renamed the inputs, you cannot use voice commands to switch inputs. Voice commands can only switch among inputs that have their original names, such as "AV," and "HDMI 1."*

# Benefits of connecting

## Connecting brings out your TV’s full potential!

### Make any night a movie night

Thousands of movies to choose from, across all major streaming movie channels like Netflix, Crackle, and more [\\*.](#) You’ll never run out of something new to watch.

### Get in the groove

Stream endless hours of music from [free](#) and subscription [-based](#) channels like [Deezer](#) and [TuneIn](#) . With [almost instant](#) [access](#) to thousands of music artists, your favorite beats are just as close as yo [ur](#) remote.

### Explore your passions

In addition to popular streaming channels like YouTube, NHL, Sky News and [Google](#) [Play](#) , your Roku TV also offers hundreds of streaming channels to fuel your passions [—](#) including fitness, cooking, religion, outdoors, Internatio [nal](#) programming and much more.

### Enjoy FREE trials of popular channels

Your Roku TV comes loaded with special offers, including free trials (if eligible) from popular streaming channels [like](#) Netflix, Hopster, Acorn TV [,](#) and many more. REMEMBER THAT YOU MUST [CANCEL BEFORE THE FREE TRIAL ENDS TO AVOID](#) SUBSCRIPTION FEES.

\* A paid subscription or other payments may be required for some channels. Channel availability is subject to change and varies by country. Not all content is available in countries or regions [where Roku® products are sold.](#)

Take advantage of awesome features

**Powerful, voice-enabled search** helps you find movies and TV shows, actors, or directors across multiple streaming channels. Search results also includes Antenna TV programs airing in your region as well. *Voice Search and Antenna TV search results are available only in the United States.*

**Smart Guide** is an electronic program guide that is available any time you are watching “over-the-air” TV programs on the Antenna TV input. You can scroll up and down to see all Antenna TV channels you receive. You can scroll left to see the previous 7 days programs, and scroll right to see the upcoming 14 days of programs. If you highlight a show that has a purple asterisk (\*), you can press the \* to see More Ways to Watch. And your most -watched channels are automatically grouped into a Favorites section at the top of the Smart Guide.

**More Ways to Watch** (U.S. only) gives you recommendations about the show you are watching on the Antenna TV, HDMI, or AV input, gives you options to stream the current show from the beginning, the entire season, or the entire series, and recommends other shows with similar themes. It also uses the shows you watch to display ads that are more relevant to you.

**Live TV Pause** lets you connect a USB drive (not provided) and pause live TV for up to 90 minutes. After pausing, you can play, fast -forward, rewind, and pause again to any point within the rolling 90 minute window.

**Voice commands** let you use your Roku Voice Remote, Roku Enhanced Voice Remote, or the Roku mobile app to change stations, TV inputs, and launch streaming channels, and more. *Voice commands are available only in the United States.*

**Mobile Private Listening** on the Roku mobile app lets you listen to streaming programs and “over-the-air” TV shows from the Antenna TV input on headphones (not provided) plugged into your iOS® or Android™ mobile device.

## What is streaming?

Streaming is viewing or listening to video or audio content that is sent over the Internet, or located on a network -connected media server or on a USB device plugged into the TV’s USB port.

With streaming, you can buy or rent most programs on demand, when it's convenient for you. When streaming, you can play, pause, rewind, and fast forward most of what you are watching. You can also replay the last few seconds again, or turn on closed captions.

**Tip:** *Some content cannot be paused or skipped. For example, if you are viewing live programming or a program that is supported by ads, you might not be allowed to skip the ads.*

Your Roku TV lets you choose from thousands of streaming channels that offer a huge selection of entertainment:

- ☒ Thousands of movies and TV episodes
- ☒ Unlimited music, live and on-demand
- ☒ Tons of live and on-demand sports
- ☒ Commercial-free kids programming
- ☒ International programming in 22 languages
- ☒ 24x7 news and in-depth news commentary

Many streaming channels are free. Some streaming channels, like Google Play, let you purchase or rent the latest movie releases or popular TV series. Some channels such as Netflix or Acorn TV charge a monthly subscription fee and others are available at no additional cost if you subscribe to a companion service through your cable or satellite provider.

If you have an existing subscription to a service like Netflix, you can just sign in with your existing user name and password.

To play streaming content, you add streaming channels to your Home screen. Use the **Streaming Channels** option on the Home screen menu to go to the Roku Channel Store, and then select the streaming channel you want to add. The channel remains on your Home screen unless you remove it, and you can watch it at any time.

For more information on using the Roku Channel Store feature, see [Using the Roku Channel Store](#).

**Note:** *A paid subscription or other payments may be required for some channels. Channel availability is subject to change and varies by country. Not all content is available in countries or regions where Roku products are sold.*

## What if I didn't connect my TV?

What if you went through Guided Setup and chose **Connect to the Internet later?** No worries. Your Roku TV makes it easy to connect whenever you want. As you move around the Home screen, you'll see several places where you can start the connection process. For example:

- ☒ Now and then you'll see a message appear on the panel to the right of the Home screen offering a **Connect Now** option. Simply highlight and select the **Connect Now** option to get started.
- ☒ Use the **Connect and activate now** option in the **Settings** menu. From the Home screen menu, select **Settings**, then **Network**, and then **Connect and activate now**.
- ☒ If you want to start over from the beginning, use the **Settings** menu to do a **Factory reset**, and then go through Guided Setup again. This time, choose your home network when prompted.

# Setting up Antenna TV

In addition to the other entertainment possibilities of your Roku TV, you may also want to watch broadcast channels from an antenna or cable TV service connected to the ANT input. On your Roku TV, you watch broadcast TV in much the same way you watch other entertainment choices. You select a tile—in this case, the **Antenna TV** tile—from the Home screen.

The first time you select the **Antenna TV** tile, you have to set up the TV tuner. Setting up the TV tuner scans for active channels and adds them to your Antenna TV channel list.

---

## Why do I have to set up the TV tuner?

Not everyone needs to use the TV tuner. For example, you might have a set top box provided by a cable or satellite company that receives all of your channels. Most of these set top boxes use an HDMI connection.

More and more people are watching only streaming TV and do not have a TV antenna or cable/satellite service. If you don't need the TV tuner, you can bypass setting it up and instead remove it from the Home screen as explained in [Remove unwanted tiles](#).

When you set up Antenna TV, the TV scans the signal on its antenna input for channels with a good signal, and adds those to the channel list, skipping dead channels and channels with a very weak signal.

The TV lets you add two analog channels, even if they have no signal, for the purpose of using an older set top box, VCR, or game console that can only output a signal on analog channel 3 or 4. Typically, you'll only need one of these channels, but both are provided to make setup simpler. You can hide the one you don't want as explained in [Edit Antenna TV channel lineup](#).

---

## How do I set up the TV tuner?

1. Make sure your antenna (not provided) or TV cable is connected to the TV's **ANT/CABLE** input.
2. On the Home screen, select the **Antenna TV** tile.
3. Read the simple on-screen instructions, and then select **Start finding channels**.



4. If prompted, select your time zone. You'll only need to do this if the TV can't figure out your time zone from your Internet connection.



---

## Why does the TV need my time zone?

The TV needs to know your time zone so that it can correctly display time information about the program you are currently watching.

---

5. When prompted, select whether to add analog channels 3 and 4 . These channels enable you to connect older set top boxes , VCRs, or game consoles.



6. Wait while your TV scans for Antenna TV stations...

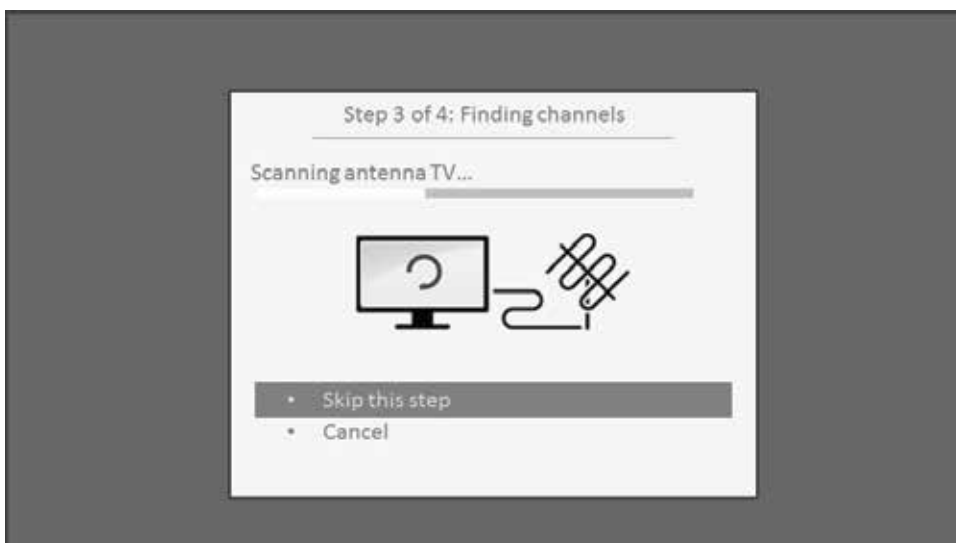



... and then cable TV channels.

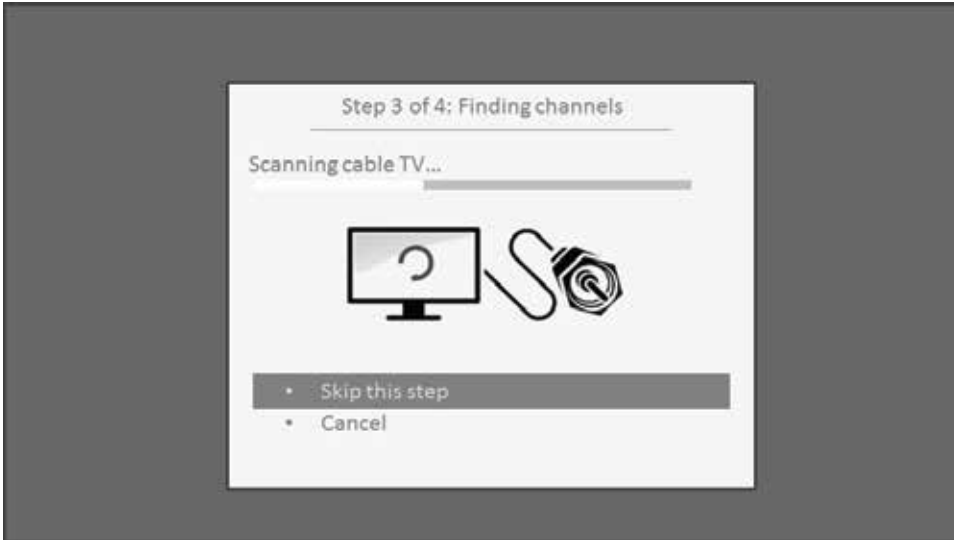

Scanning for channels can take several minutes.

**Tip:** *If you use a set-top box to receive cable TV channels (and don't have your cable connected directly to the TV's **ANT** input), you can save time by skipping the cable TV portion of the channel scan.*

7. When the channel scans finish, the TV shows the number of channels it added.





8. *Only in connected mode* , you have the option of setting up Live TV Pause. The topic [Pausing Live TV](#) explains how to set up and use this feature. If you don't want to set up Live TV Pause, or if this option is not available to you, select **Done** to start watching Live TV.

**Tip:** *Repeat the channel scan from time to time to make sure you are receiving all of the latest channels. Broadcasters add and remove channels, move channels to different parts of the spectrum, and change the power levels of their channels periodically. Your antenna reception and picture quality depend on the position of your antenna and on your location relative to the antennas of broadcasters in your area.*

**Note:** *You'll have to repeat the channel scan if you remove and re-add the **Antenna TV** tile from the Home screen or perform a factory reset. To repeat the channel scan, go to **Settings > TV inputs > Antenna TV > Scan again for channels > Start finding channels**.*

Now, you're ready to watch Antenna TV! While you're watching, try the following tips :

- ☒ Press the **UP** and **DOWN** arrows to change channels.
- ☒ Press the **LEFT** arrow to display the channel list (non-connected mode) or Smart Guide (connected mode), and then use the **UP** and **DOWN** arrows to select a channel to watch. Or press **REWIND** or **FAST FORWARD** to jump through the channel list or Smart Guide a page at a time.
- ☒ Press **OK** to display information about the current program.
- ☒ Press **\*** to see options for picture and sound settings.
- ☒ *Only on models that have a Roku voice remote* , hold down  or  , and then say the name of a movie, TV show, actor, or director. The TV displays the result and the streaming channels that offer the requested content. *Only in the United States* , the results also include shows on Antenna TV channels .

**Note:** *If you do not have a Roku voice remote , you can use the Roku mobile app to search . For more information, see [Getting and using the Roku mobile app](#) .*

# Using your TV

This section provides information on using the day-to-day features of your TV.

## Status indicator

Your TV has a single status indicator. It goes on and off and blinks in different ways depending on the status of the TV, as shown in the following table:

| TV CONDITION                   | STATUS INDICATOR                                 | MEANING  |
|--------------------------------|--|--|
| On (screen is active)          | Off  | Screen is communicating that TV is on.   |
| Screensaver (screen is active) | Off  | Screen is communicating that TV is on.   |
| Off (no power)                 | Off  | TV is not connected to power.  |
| Off (standby)                  | On   | TV is connected to power and is ready to use.                                      |
| Starting up from off state     | Slow pulsing blink until startup completes       | TV is doing something.   |
| On (receiving update from USB) | Slow pulsing blink until update completes        | TV is doing something.   |
| Remote command received        | Dims on/off once                                 | TV has received your command.  |
| Network connection lost        | Two short blinks, pause, repeat                  | TV was connected and paired with a Roku account and now has no network connection. |
| Powering down to standby mode  | Slow pulsing blink until the TV reaches standby. | TV is doing something.   |

## Standby mode energy savings

When you turn off your TV, it remains in a higher power mode for a few minutes, after which it goes into a very low power standby mode. If you turn on the TV again before it has entered the very low power mode, it turns on immediately. After the TV goes into the lower power standby mode, it takes a few seconds longer to start up.

*Only in connected mode* on TVs that do not have an Energy Star rating, you can optionally enable **Fast TV start**. When this option is enabled, your TV starts up almost immediately regardless of how long it has been turned off, but uses somewhat more power in standby mode. For more information, see [Fast TV start](#).

## Opting in to Smart TV experience (U.S. only)

*Only in connected mode in the United States*, the first time you select Antenna TV, an HDMI input, or AV input, your TV offers to enable the Smart TV experience. If you decide to enable it at this time, you're all set to enjoy its recommendations and features.

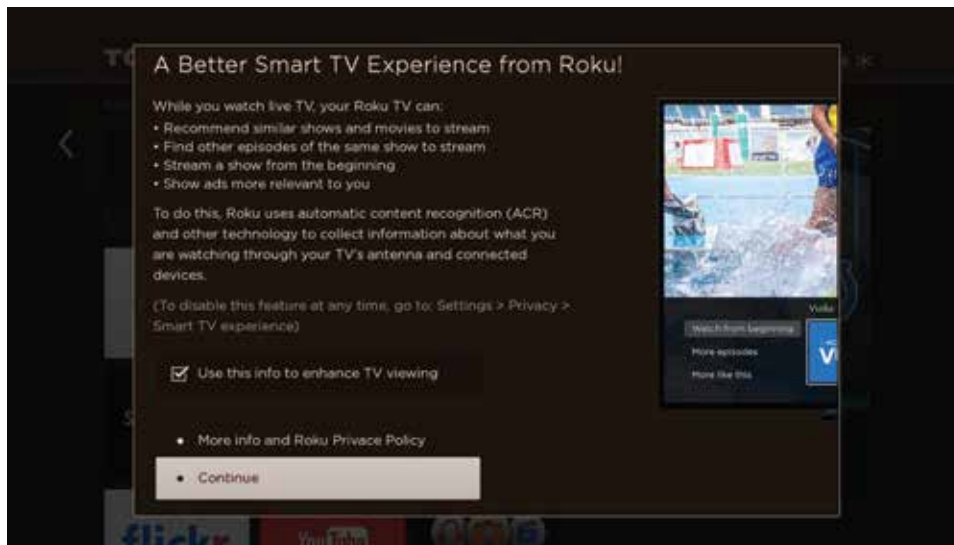

The Smart TV experience uses automatic content recognition (ACR) and other technology to collect information about what you watch through your Antenna TV, and on devices like media players and cable boxes connected to the HDMI or AV inputs. Opting in means that you give permission to analyze the programs you watch for the purpose of making recommendations, as well showing ads that are more relevant to you.

If you decide not to enable the Smart TV experience at this first opportunity, you can enable it later. Or, if you decide you'd rather not use the feature, you can disable it, but be aware that previously collected information is retained and not deleted.

## Disable Smart TV experience

If you decide you want to disable Smart TV experience, follow these steps:

1. From the Home screen, go to **Settings > Privacy > Smart TV experience**.
2. Navigate to the right to highlight **Use info from TV inputs**.
3. Press **OK** on the remote to clear the check box.

## Disable Auto Notifications

If you want to keep the Smart TV experience enabled, but you do not want to see notifications while you are watching shows, you can disable notifications. To do so, follow these steps:

1. From the Home screen, go to **Settings > Privacy > Smart TV experience**.
2. Navigate to the right to highlight **Use info from TV inputs**.
3. Press **DOWN** on the remote to highlight **Enable auto notifications**.
4. Press **OK** on the remote to clear the check box.



**Note:** *These settings do not affect recommendations for More Ways to Watch that you see in the Smart Guide when watching Antenna TV channels. Those recommendations come from the Smart Guide and do not rely on ACR technology.*

# Watching Antenna TV channels

Select the **Antenna TV** tile in the Home screen. Your TV remembers the last channel you watched and starts with that channel playing.

## Changing channels

To change channels, you can do any of the following:

- ☒ Press the **UP** arrow to change to the next higher channel.
- ☒ Press the **DOWN** arrow to change to the next lower channel.
- ☒ Press the **LEFT** arrow to display the channel list (in non-connected mode) or Smart Guide (in connected mode), and then press the arrow keys to select the channel or show you want to watch. Press **REWIND** and **FAST FORWARD** to move through the list one page at a time. When you've highlighted the channel or show you want to watch, press **OK**. (If you decide you don't want to change channels, press the **BACK** button).
- ☒ *Only if Live TV Pause is not enabled*, press  to jump to the previous channel. Press again to return to the channel you were watching before you pressed .

**Note:** If the  button is not available on your remote, you can use this feature in the Roku mobile app. For more information, see [Getting and using the Roku mobile app](#).

## Favorite Channels in non-connected mode

You can quickly change from surfing among all channels or only your favorite channels. First, you have to mark one or more channels as your favorites.

**Note:** *In the United States, in connected mode, favorite channels appear at the top of the Smart Guide automatically after several days of watching Antenna TV channels.*

For details, see [Smart Guide](#).

### Mark your favorite channels

In non-connected mode, you can make any channel a favorite whenever you're watching Antenna TV channels.

1. Press the **LEFT** arrow to display the channel list. Notice that the words **All channels** appear at the top of the channel list.
2. Scroll up or down to highlight a channel that you want to make a favorite.
3. Press **\***. At this point, you'll see two options:
  - ☒ **Add to favorites**
  - ☒ **Back**
4. With **Add to favorites** highlighted, press **OK**. A  symbol appears adjacent to the channel to indicate that it is now a favorite.
5. Repeat these steps to add more favorite channels.

## Surf only your favorite channels

In non-connected mode, after you've marked one or more channels as favorites, you can switch to your favorite channels whenever you're watching Antenna TV channels.

1. Press the **LEFT** arrow to display the channel list.
2. Press the **LEFT** or **RIGHT** arrow once to switch to **Favorites**. Notice that the word **Favorites** appears at the top of the channel list.
3. Highlight a channel and press **OK** to select one of the channels in the **Favorites** channel list, or wait a few moments until the channel list disappears.
4. Press the **UP** or **DOWN** arrow to change to the previous or next favorite channel. Each channel you select in this way is a favorite channel. Your channel surfing is limited to favorite channels only.

Your favorite channel list remains in effect even if you turn off or unplug your TV, until you switch back to all channels.

Note that when you press **OK** to view the program information banner while watching a show, a  symbol appears below the channel number.

## Surf all channels again

In non-connected mode, you can switch back to all channels whenever you're watching Antenna TV channels.

1. Press the **LEFT** arrow to display the channel list.
2. Press the **LEFT** or **RIGHT** arrow once to switch to **All channels**. Notice that the words **All channels** appear at the top of the channel list.
3. Highlight a channel and press **OK** to select one of the channels in the **All channels** list, or wait a few moments until the channel list disappears.
4. Press the **UP** or **DOWN** arrow to change to the previous or next channel among all your available channels. You can surf among all channels in your channel list.



## Remove a channel from your favorites

In non-connected mode, you can remove a channel from your favorites whenever you're watching the Antenna TV input.

1. Press the **LEFT** arrow to display either channel list — **All channels** or **Favorites**.
2. Scroll up or down to highlight a favorite channel that you want to remove from your favorites.
3. Press **\*** on your remote. At this point, you'll see two options:
  - ☒ **Remove from favorites**
  - ☒ **Back**
4. With **Remove from favorites** highlighted, press **OK**. The  symbol adjacent to the channel disappears.
5. Repeat these steps to remove other channels from Favorites.

## Smart Guide (U.S. only)

*Only in connected mode in the United States*, use the Smart Guide to find over-the-air TV shows through the Antenna TV input. The Smart Guide lets you scroll through all TV channels (except those you have hidden, if any). You can see all the shows from today, the previous 7 days, and the upcoming 14 days.

The ability to see shows that have already aired during the previous week enables you to use More Ways to Watch to catch up on missed movies or episodes by selecting them from one of the streaming channels. Your clue that there are More Ways to Watch a show is a purple asterisk (\*) next to the program name in the guide.

For example, you might turn on your TV at 10 minutes past the hour and discover you are missing the current episode of *Empire*. But, there is a purple asterisk next to the show title, so you can press **\*** and find that there are several streaming channels where you can watch the current episode from the beginning. You also can find more episodes of *Empire*, and other shows that have a similar theme.

**Note:** *A paid subscription or other payments may be required for some channels.*

To view the Smart Guide, press the **LEFT** arrow. The Smart Guide opens showing the name of the current program highlighted, and a lot more information.



1. Program information for the highlighted show. See [Viewing program information](#) for details.
2. More Ways to Watch indicator. See [More Ways to Watch](#) for more information.
3. Channel list. Navigate with the **UP** and **DOWN** arrows.
4. Time slots. Navigate with the **LEFT** and **RIGHT** arrows. Use the **FF** and **REW** buttons to skip ahead or back 24 hours.
5. Program list
6. Progress bar showing the approximate time with respect to the time slots.

As you navigate, notice that the Smart Guide shows a light gray background for programs and portions of programs that have already aired. It shows a black background for programs and portions of programs that have not yet aired. The line dividing these two zones is the progress bar.

### Navigating the Smart Guide

- ☒ To switch to a program that is currently in progress, highlight it, and then press **OK**.
- ☒ To return to the current time after navigating to a different time slot, press **REPLAY** .
- ☒ To return to the currently airing program without causing a channel change, press **BACK**.
- ☒ To see More Ways to Watch, highlight any show that has a purple asterisk (**\***), and then press **\***.

## Favorite channels in the Smart Guide

The Smart Guide organizes your favorite channels at the top of the program list for convenient access. It does this automatically as you use your TV over several days. If you would prefer not to have a favorites section in the Smart Guide, you can turn this feature off.

### Turn off favorite channels

1. From the Home screen menu, navigate to **Settings > TV inputs > Antenna TV > Favorite channels**.
2. Highlight **Enable 'Favorite channels'**.
3. Press **OK** to clear the check mark.

## Viewing program information

You can view program information in different ways:

- ☒ *Only in connected mode in the United States*, view program information for any program listed in the Smart Guide. Press the **LEFT** arrow while watching Antenna TV to see the Smart Guide. For more information, see [Smart Guide](#).
- ☒ View program information for the current program in a banner at the bottom of the screen. You can view program information in this way on both connected and non-connected TVs. The following illustration shows the information that is available:



### Program information banner

Program information might include any or all of the following, depending on availability within the broadcast information:

- ☒ Channel number
- ☒ Channel call sign
- ☒ Favorite channel icon 
- ☒ Signal strength
- ☒ Program title and episode name/number
- ☒ Start time, end time, and graph of program length showing current position
- ☒ Content rating
- ☒ Video resolution ( 480i, 480p, 720p, 1080i, 1080p, 4K )
- ☒ Frame rate (24Hz, 30Hz, 60Hz for television sources, 60Hz, 70Hz, 72Hz, 75Hz for computer sources)
- ☒ Audio format (Mono, Stereo, Dolby Audio™ logo)
- ☒ Audio features (SAP /MTS )
- ☒ Only on select 4K models: HDR or Dolby Vision™\* logo (HDMI 2.0 and streaming sources)
- ☒ Closed captioning (CC)
- ☒ Current time
- ☒ Program description. If the entire description does not fit, press OK to expand the size of the banner and see the entire description.

**Tip:** If you've set up Live TV Pause and you're watching Antenna TV, you'll also see a progress bar showing the current playback position within the rolling 90-minute pause time. For more information, see [Pausing Live TV](#).

\* The Dolby Vision™ logo appears only on Dolby Vision™-certified models when displaying Dolby Vision™ content.

## Adjusting settings while watching a show

Press **\*** to display the **Options** menu (except when you are viewing the program information banner) . Press the **UP** and **DOWN** arrow s to highlight an option, and then press the **LEFT** and **RIGHT** arrow s to change the setting. The topic [Adjusting TV settings](#) explains each of the settings in detail.

## Pausing Live TV

Live TV Pause gives your Roku TV the ability to pause, play, fast forward, and rewind digital Antenna TV . You can pause Antenna TV for up to 90 minutes.

### Requirements

To use this feature, you need to:

1. Connect your TV to the Internet. If you didn't connect during Guided Setup, see [What if I didn't connect my TV?](#)
2. Provide your own dedicated USB drive with the following minimum specifications.
  - ☒ 16 GB
  - ☒ 15 Mbps read/write speed
  - ☒ USB 2.0 compliant

A USB flash drive (thumb drive) meeting the minimum requirements is highly recommended. Note that using a larger drive does not extend the 90 minute pause time.

**Important:** *After warning you and giving you a chance to cancel Live TV Pause setup, all existing content on your USB drive is erased when you enable this feature.*

3. Connect your USB drive to the TV's USB port.

**Important:** *Some TV models have more than one USB port. You can connect your Live TV Pause USB drive to any port, but make sure that nothing is connected to other USB ports while enabling Live TV Pause. Reconnect other USB devices after you have finished enabling Live TV Pause.*

4. Enable Live TV Pause , as explained in the following topic .

## Enabling Live TV Pause

You can start setting up Live TV Pause in any of the following ways :

- ☒ Go to **Settings > TV inputs > Antenna TV > Live TV Pause**, and then select **Enable**.
- ☒ After completing a channel scan, select **Set up Live TV Pause** from the available options.
- ☒ Press **Play/Pause** on the Roku remote while watching a digital Antenna TV channel.
- ☒ Highlight the Antenna TV tile on the Home screen, press **\*** on the remote, and then select **Enable Live TV Pause**.

After starting setup of Live TV Pause in any of these ways, the TV prompts you through the steps needed to enable this feature. Setup takes only a few moments.

**Note:** *Use of a USB hub is not supported.*

## Using Live TV Pause

If you have used the Roku remote to watch streaming channels, using Live TV Pause should be very familiar to you.

- ☒ While watching a digital Antenna TV channel, press **PLAY/PAUSE** to pause or play the content. After the TV program has been paused for 90 minutes, the TV resumes playing.
- ☒ After watching a channel for a while, press **REWIND** to jump back up to the point where you first started watching the channel, up to 90 minutes.
- ☒ After pausing or rewinding, press **FAST FORWARD** to jump ahead up to the point where you are once again watching the live TV program.
- ☒ Press **FAST FORWARD** or **REWIND** repeatedly to cycle through 1x, 2x, and 3x skip speeds. Press **INSTANT REPLAY**  to play back the last several seconds of the program.

- ☒ When the program is paused, press the **LEFT** and **RIGHT** arrows to move forward and backward through the program approximately 10 seconds per press. Small frames appear across the screen to identify your location in the program.

**Note:** If the  button is not available on your remote, you can use the Roku mobile app. For more information, see [Getting and using the Roku mobile app](#).

Whenever you use any of the Live TV Pause features, the TV momentarily displays a progress bar:



1. Time at current playback position.
2. Current playback position
3. Extent of pause time, representing the amount of time this channel has been buffered, up to 90 minutes.
4. 90 minute mark, representing the maximum extent of pause time.
5. Current time.

The progress bar also displays tick marks at each half hour point, to help you locate the boundaries where one show ends and a new one begins.

## Notes about Live TV Pause

- ☒ You can use Live TV Pause only with digital broadcast and cable channels received through the TV's ANT input (ATSC and Clear QAM channels).
- ☒ Changing channels erases and restarts the Live TV Pause buffer.
- ☒ Returning to the Home screen, selecting another input, or turning off the TV erases and resets the Live TV Pause buffer.
- ☒ Removing the USB drive erases the Live TV Pause buffer.

## More Ways to Watch (U.S. only)

*Only in connected mode in the United States*, More Ways to Watch gives you recommendations about the shows you're watching on the Antenna TV, HDMI, or AV input. You will automatically get these recommendations in the Smart Guide and in the program information banner for Antenna TV programs. However, before you can get recommendations for shows you're watching through the HDMI or AV inputs, you must opt into the Smart TV experience to acknowledge that you want to allow the TV to use automatic content recognition (ACR). See [Opting in to Smart TV experience](#) for details.

Not every show provides recommendations. For details about what you'll see when a recommendation appears, see [Using More Ways to Watch](#).



## Using More Ways to Watch

As you use More Ways to Watch, be aware that you'll only see suggestions on your TV when all of the following conditions are met:

- ☒ Your TV is operating in connected mode in the United States.
- ☒ If you are watching shows through an HDMI or AV input, you've enabled **Smart TV experience**. (If you are watching Antenna TV channels, this setting does not matter.)
- ☒ The program you're watching contains the information needed to identify it. Note that some programs, such as the daily news, typically do not activate More Ways to Watch.
- ☒ At least one participating streaming channel offers the movie or TV show you are watching, or other episodes, or more shows like the one you are watching.

If all of these conditions are met, you can view the suggestions. More Ways to Watch recommendations appear in several places:

- ☒ When watching through the HDMI and AV inputs, you'll see a **More Ways to Watch** notification in the lower right corner of the screen for a few seconds unless you have disabled **Enable auto notifications**:



**Note:** After this banner disappears, you can restore the More Ways to Watch prompt by pressing **OK**.

- ☒ For shows on Antenna TV channels, check the program information banner that appears for a few moments when you change channels or when you press **OK** while watching a show. If your TV has suggestions, you'll see a **More Ways to Watch** notification in the banner:

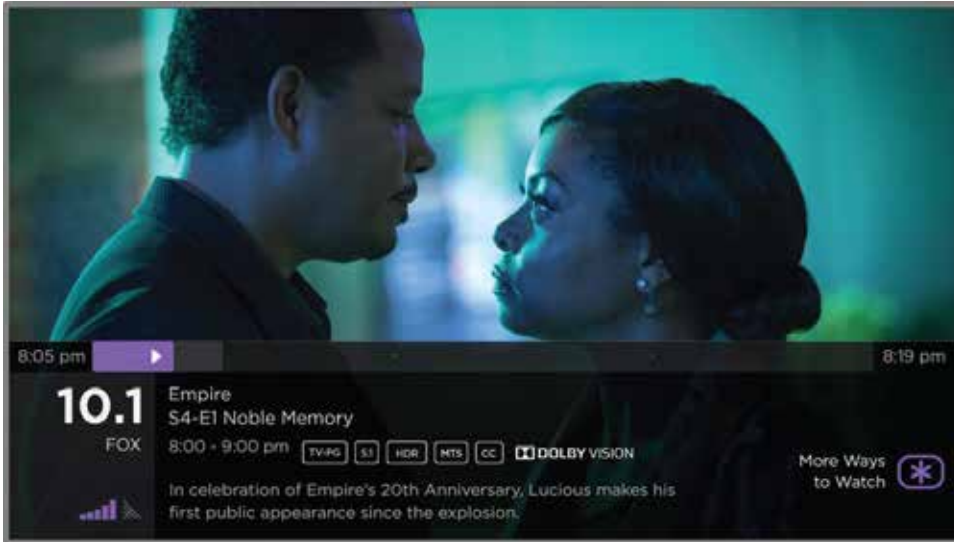

- ☒ In the Smart Guide, you can view **More Ways to Watch** recommendations on any program that shows a purple asterisk \* next to its title:

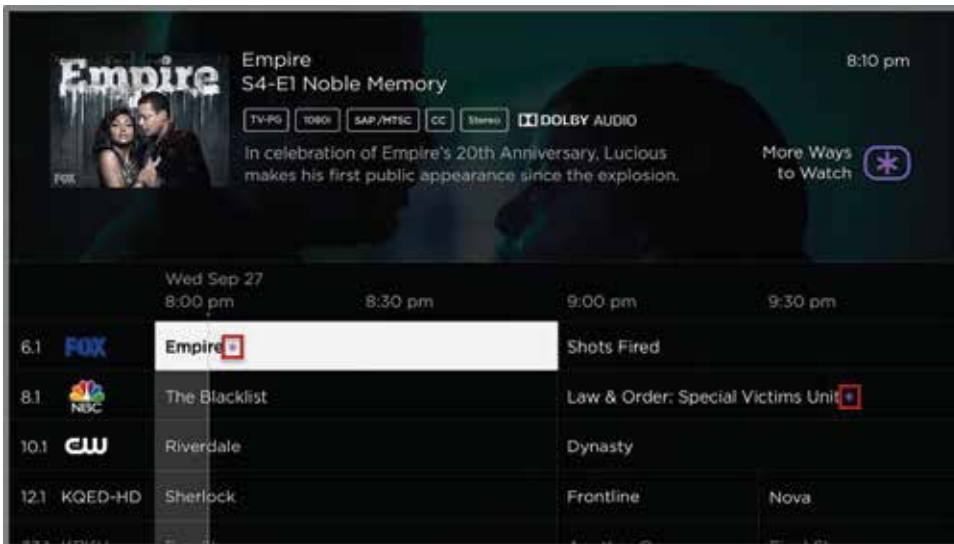

Regardless of which **More Ways to Watch** prompt appears, press **\*** to see the recommendations. The options you'll see depend on the type of show you're watching and the available ways there are to watch, so you might see any or all of the following:

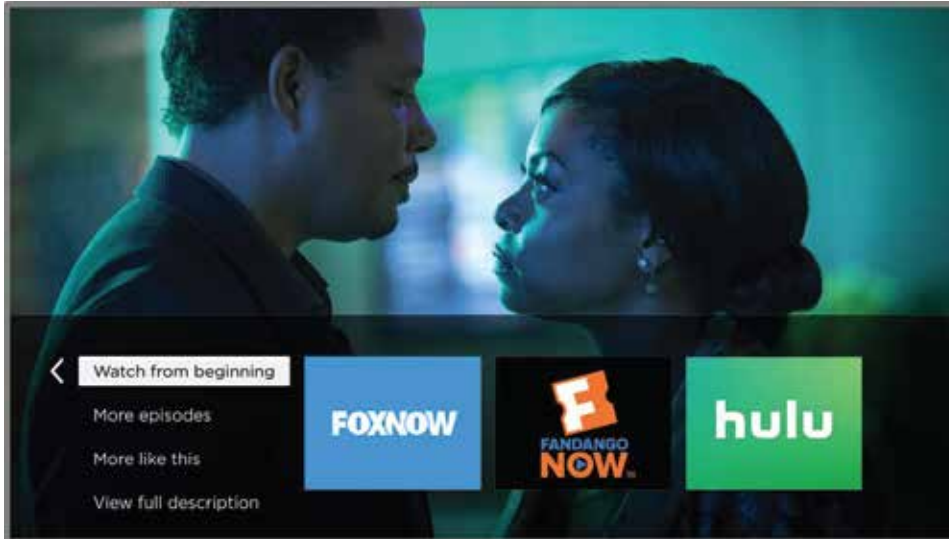

- ☒ **Watch from beginning** – Streaming channels on which the same TV show or movie is available. Generally, this option does not appear on first run programs, because streaming content is not available until a later date.
- ☒ **More episodes** – Streaming channels where you can find other episodes of the TV show you are watching. Does not apply to movies.
- ☒ **More like this** – TV shows or movies with a similar theme.
- ☒ **View full description** – Full description of the selected show.

Press the **DOWN** arrow to select an option, and then press the **RIGHT** arrow to select the channel you want to use to watch from the beginning or watch more episodes, or the other TV show or movie with a similar theme.

Assuming you've already added the channel and completed any required sign-in, **More Ways to Watch** takes you directly to the program in the streaming channel where you can select and watch the program. Otherwise, it prompts you to add the channel and, if you do, then takes you to the show.

## Getting the most from More Ways to Watch

- ☒ Streaming channels you've already installed appear first in the list of suggestions.
- ☒ When you select a streaming channel, you leave the program you are currently watching.
- ☒ If you've used the Live TV Pause feature to pause the program, your paused program buffer is deleted. In other words, you cannot return to a channel and resume watching where you left off.

## Switching TV inputs

Switch TV input to access the device connected to that input, for example, a Blu-ray™ player. Switching inputs is as simple as highlighting the input's tile in the Home screen, and pressing **OK**. The video signal on the input, if any, plays on the screen.

**Tip:** To learn how to add, remove, rename, and rearrange the tiles on your Home screen, see [Customizing your TV](#).

## Auto-detecting devices

Your TV automatically detects when you connect a new device to an HDMI® input and turn on its power. The input is automatically added to the Home screen if it isn't already present.

## Adjusting audio/video settings

While watching video content on any input, press **\*** to display the **Options** menu. Press the **UP** and **DOWN** arrow keys to highlight an option, and then press the **LEFT** and **RIGHT** arrow keys to change the setting. To learn about each of the audio and video settings, see [Adjusting TV settings](#).

# Playing content from USB storage devices

*Only in connected mode*, your Home screen has the **Roku Media Player** tile. Otherwise, the Home screen has the **USB Media Player** tile. You can play personal music, video, and photo files from a personal USB flash drive or hard disk connected to the TV's USB port.

To use this feature, make sure your media files are compatible with the Roku/USB Media Player. To see the latest list of supported formats, view **Help** in the Media Player\*. The Roku/USB Media Player displays supported file types only, and hides file types it knows it cannot play.

For more information about playing back your personal videos, music, and photos, go to the following link on the Roku web site:

[go.roku.com/rokumediaplayer](http://go.roku.com/rokumediaplayer)

## Auto player launch

*Only in connected mode*, you can set your TV to automatically open the Roku Media Player when you connect a USB drive with a recognizable file system (such as FAT16 /32, NTFS, HFS+ or EXT2/3). To configure this setting, from the Home screen, navigate to **Settings > System > USB media**. At this point, the following options are available:

- Auto-launch** – Choose **Prompt**, **On**, or **Off**, as desired.
  - **Prompt** – (default) Display a prompt each time a recognized USB drive is connected. The prompt provides options to launch the Roku Media Player as well as to change future auto-play behavior.
  - **On** – Always launch the Roku Media Player whenever you connect a recognized USB drive.
  - **Off** – Never launch the Roku Media Player automatically.
- Launch channel** – Choose the app you want to use to play back media files.

---

\* There are many variants of each supported media format. Some variants may not play at all or may have issues or inconsistencies during playback.

## Playing content from local network media servers

Only in *connected mode*, your TV can play personal video, music, and photo files from a media server on your local network. Media servers include personal computers running media server software such as Plex or Windows Media Player, network file storage systems that have built-in media server software, and other devices that implement the specifications of the Digital Living Network Alliance. Some servers do not fully implement the DLNA specification but are UPNP (Universal Plug and Play) compatible. The Roku Media Player will connect to them as well.

Some media servers can convert files into Roku compatible formats. DRM-protected content is not supported.

## Using your TV in a hotel or dorm room

Hotels, school dorms, conference facilities, and similar locations with public wireless Internet access often require you to interact with a web page to authenticate your access. These types of networks are called *restricted public networks*. When you select a network of this type, the TV automatically detects that additional information is needed and prompts you through using another wireless device to supply the requested information.

### About using your TV on a restricted public network

Here are some points to keep in mind when using your TV on a restricted public network:

- ☒ Using your Roku TV on a hotel or dorm room network requires wireless availability and a network-connected smartphone, tablet, or computer to authenticate access to your wireless access point.
- ☒ You will need your Roku TV remote.
- ☒ Some content might be limited or unavailable if you try to connect outside your home country due to geo-filtering.

## Getting your Roku TV on line on a restricted public network

1. Either during Guided Setup or after using the **Settings > Network** menu to set up a new connection, the TV automatically detects that you are connecting to a restricted network and displays the following prompt:

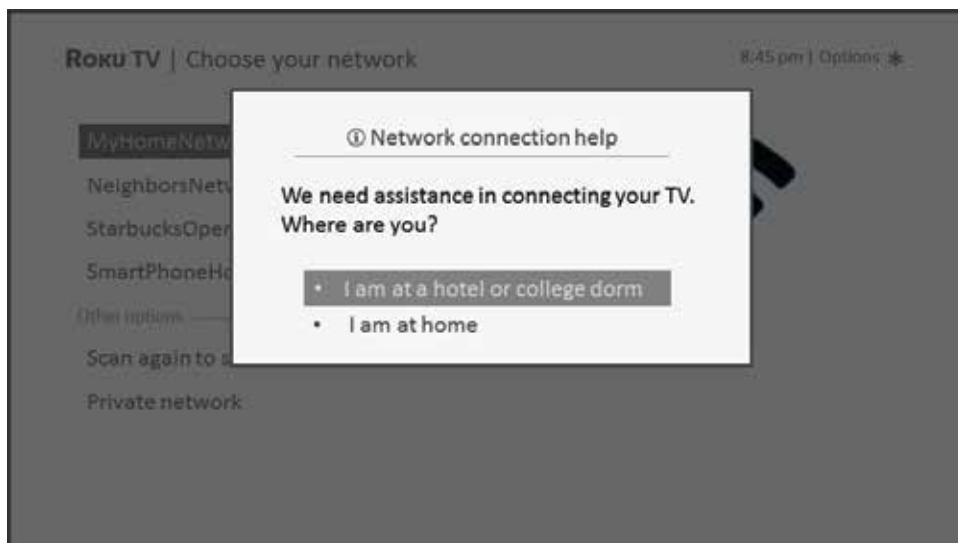

**Tip:** Your TV can connect to a restricted network only if **Enable 'Device connect'** is selected in **Settings > System > Advanced system settings**. (*Device connect* is enabled by default, but if you have disabled it, the TV cannot complete the connection.)

**Note:** *Device connect* is not present if the TV is in non-connected mode.

2. After selecting the correct network, highlight **I am at a hotel or college dorm**, and then press **OK**. The TV prompts you to use your smartphone, tablet, or laptop to complete the connection.

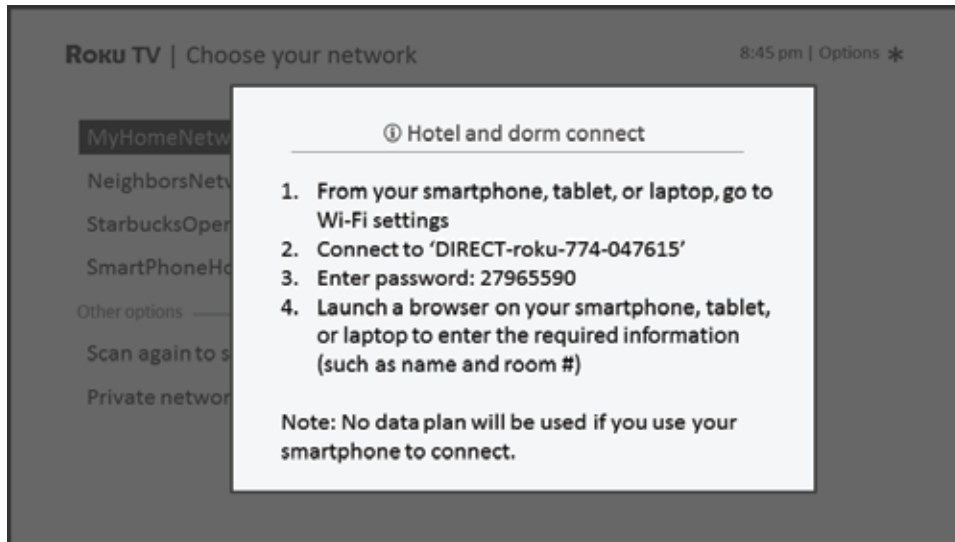

3. Use a phone, tablet, or wireless -enabled computer to det ect wireless networks. In most cases, you can simply open the device's Wi-Fi Settings or Network Settings screen to start scanning.

**Note:** *The phone, tablet, or computer must be on the same wireless network to which you are connecting the TV.*

4. Connect to the network named on your TV screen. The actual network name varies.

**Note:** *The previous step connects your smartphone, tablet, or computer directly to the TV. No connection charges apply and the connection does not impact your device's data plan.*

5. The wireless connection process prompts you for a password. Enter the password as shown on the TV screen. The actual password varies.
6. Start the web browser on your smartphone, tablet, or computer. When you attempt to open any web page, the restricted connectio n will prompt you for whatever information it needs. In most cases, you must agree to terms and conditions, provide identifying information, or enter a password, PIN, or room number to proceed. The information requested depends on the organization that con trols the wireless connection.



7. After you enter the requested information, the TV automatically proceeds to complete its connection and resumes normal operation.
8. If the TV prompts you to link to your Roku account, use your smartphone, tablet, or computer to complete the pairing operation and activate your Roku TV.

## Roku voice remotes (select models only)

*Only on TVs with the Roku voice remotes* : The following topics explain how to get the most out of your TV when it includes a Roku Voice Remote or Roku Enhanced Voice Remote.

### Re-pairing your Roku voice remote

The Roku voice remotes operate with wireless radio-frequency signals and must be paired with your TV. You initially paired the remote when you set up your TV during Guided Setup. But if your remote loses its pairing with the TV for some reason, you can easily re-pair it using either of the following methods:

1. Remove the battery cover from the back of the remote.
2. Press and hold down the pairing button for 3 seconds or longer, until the adjacent LED lights up.
3. Do one of the following:
  - ☒ Turn on the TV using the power button on the TV side or back panel. Pairing occurs as the TV starts up.
  - ☒ Use the Roku mobile app or a different remote to navigate to **Settings > Remote > Pair remote**.

**Tip:** *If the remote fails to pair with the TV, try installing new batteries. Also, it's helpful to hold the remote within two to three feet of the TV to ensure successful pairing.*

### Checking the Roku voice remote battery level

You can check the condition of the batteries in your Roku voice remote at any time by navigating to **Settings > Remote > Battery level**. The resulting screen displays not

only the battery level, but also other information that can be useful when you need technical support with your remote.

**Tip:** When you first turn on the TV, a battery level indicator appears in the upper right corner of the screen for a few seconds.

## Finding your Roku Enhanced Voice Remote

Only on TVs with the Roku Enhanced Voice Remote, when your remote has found its way down into the sofa cushions or your dog has hidden it in the corner, you can use the Find Remote feature to find out where it's hiding. This feature has a limited range, and is designed to find your Enhanced Voice Remote somewhere in the same room as the TV.

Select **Find Remote** on the **Settings > Remote** menu to see brief instructions on how to activate the Find Remote feature. Note, however, that selecting this option doesn't actually activate the feature. Here are the complete instructions:

### Activate Find Remote

- ☒ If your TV has a joystick-style control, press to the **Left** or **Right** to open the **Inputs** menu, and then press **Right** to scroll down to **Find Remote**.
- ☒ If your TV has a column of labeled panel buttons, press the **INPUT** button to open the **Inputs** menu, and then press the **INPUT** button again until you highlight **Find Remote**.



A moment or two after highlighting **Find Remote**, the Roku Enhanced Voice Remote starts playing your selected Find Remote sound to let you know where it is hiding.

The sound automatically stops after a minute, or after you find the remote and press any button.

## Changing and previewing the Enhanced Voice Remote finder sound

*Only on TVs with the Roku Enhanced Voice Remote*, you can customize the sound your remote makes when you use the Find Remote feature. To customize the sound, navigate to **Settings > Remote > Change remote finder sound**. Select the sound you want to use from the available settings.

To preview the sound you have chosen, select **Preview remote finder sound**, and then hold down **OK** on the remote to play the sound. When you release the **OK** button, the sound will stop.

# Adjusting TV settings

You can adjust most picture and sound settings while you are watching a program by pressing **\*** to open the **Options** menu. There are some additional picture and sound settings in the **Settings** menu.

In most cases, the changes you make apply only to the input you are using. Antenna TV, the separate HDMI® inputs, and the AV input each have their own settings that the TV remembers when you return to that input. The TV also separately remembers the settings you specify while viewing streaming content.

## Settings menu

Use the **Settings** menu to adjust overall TV settings. Press  to go to the Home screen, and then navigate to **Settings > TV picture settings**.

You can adjust the following overall TV picture settings from the **Settings screen**:

- ☒ **TV brightness** – Provide a better viewing experience in darker or brighter rooms. Increases or decreases the TV's general brightness across all TV inputs.

**Note:** *This setting is identical to the **TV brightness** setting you can access in the **Options** menu while watching a program.*

- ☒ **HDR notification** – *On select models only*: Controls whether the TV displays a notification in the upper right corner of the screen for a few seconds when HDR or Dolby Vision content begins to play.
  - **On** – The TV displays a notification when HDR or Dolby Vision content begins to play.
  - **Off** – The TV does not display a notification when HDR or Dolby Vision content begins to play.

**Note:** *This setting does not affect the HDR or Dolby Vision notification that always appears in the program information banner. Press **OK** while watching a show to open the program information banner.*

- ☒ **Settings per input** – Lists each TV input. Select an input, and then press **\*** to display the **Options** menu where you can adjust the input's settings while watching a live picture and listening to the sound from that input.

**Tip:** *You don't have to go to the **Settings** menu first —you can display an input's **Options** menu and adjust its settings whenever you are watching the input by pressing **\***.*

## Options menu

The **Options** menu for each TV input provides many settings for controlling the appearance of the picture and the quality of the audio. To view the **Options** menu, press **\*** whenever you are watching a TV input or streaming a video (except when you are viewing the program information banner). The **Options** menu is a panel that appears over the left side of the screen:



Typical Options menu

To adjust the settings on the **Options** menu, press the **UP** or **DOWN** arrow to highlight a setting, and then press the **LEFT** or **RIGHT** arrow to change the setting. You'll see the changes you make right away in picture appearance or audio quality.

**Tip:** When you highlight a setting, the header text explains the effect of its current value. When you begin to adjust a setting, the other options are hidden so you can see more of the screen. Even though the other settings are hidden, you can move the highlight up or down to adjust the other settings. As soon as you press the **UP** or **DOWN** arrow, the other settings become visible again.

## Options menu settings

- ☒ **TV brightness** – Affects the overall brightness of the picture. *This setting applies across the entire TV; that is, to all TV inputs and is identical to the **brightness** setting under **Settings > TV picture settings**.* **TV**
- ☒ **Picture mode** – Provides picture presets for various viewing preferences. *This setting applies to the currently -selected input only.*
- ☒ **Picture size** – Adjusts the aspect ratio of the picture, enabling you to view a picture in its original format, or zoom or stretch it to fill the screen. The **Auto** setting has been found to produce the best picture in most cases.
- ☒ **Audio effect** – Adjusts the sound quality output from the TV speakers. *This setting applies across the entire TV; that is, to all TV inputs. It does not affect the sound quality for headphones, **HDMI (ARC)**, or **SPDIF (TOSLINK)** connectors.*
- ☒ **Sleep timer** – Sets a timer that turns off the TV after the specific amount of time. *This setting remains in effect even if you stop watching the current input.*
- ☒ **Closed captioning** – Controls when you see captions. *This setting is only offered for **Antenna TV**, the **AV input**, and streaming videos. Any set value remains in effect across only these inputs.*

  - **Antenna TV** – Set captions to off, always on, on only when the TV sound is muted, or on only during instant replay (when Live TV Pause has been enabled).
  - **AV input** – Set captions to off, always on, or on only when the TV sound is muted.
  - **Streaming video channel** – For streaming content that provides closed captions, set captions to off, always on, on only when the TV sound is

muted, or on only during instant replay (for streaming content that supports instant replay). *Note that some streaming channels have other methods for turning captions on and off. In these cases, the **Closed captioning** option does not appear on the **Options** menu.*

**Note:** *If the  button is not available on your remote, you can use this feature in the Roku mobile app. For more information, see [Getting and using the Roku mobile app](#).*

- ☒ **Captioning track** – *Only in Canada* : Selects which caption track to display when Closed Captioning is on. *This setting remains in effect on all inputs that provide captions.*

**Note:** *Only in the United States, the **Captioning track** setting is located under **Accessibility**.*

- ☒ **SAP** – Selects whether to play a secondary audio program or multichannel television sound, and which choice to play. *This setting applies only to Antenna TV on digital channels.*

- ☒ **Advanced audio settings** – *Only on select models* : Shows the [Advanced audio settings menu](#).

- ☒ **Advanced picture settings** – Shows the [Advanced picture settings menu](#).

**Tip:** *To dismiss the **Options** menu, just wait a few seconds without pressing any buttons. Or press **\*** again to dismiss the menu immediately.*

## Accessibility (U.S. only)

*Only in the United States*, the settings on the **Accessibility** menu enable you to change the TV's accessibility settings without leaving the program you are watching. These settings are also available on the **Home** screen under **Settings > Accessibility**.



### Accessibility menu settings

- ☒ **Audio Guide** – Turn the Audio Guide on or off. The Audio Guide is a text-to-speech screen reader that helps blind and low-vision users navigate the Roku user interface and on-screen menus. When enabled, the Audio Guide reads out text, menus, and other on-screen items.

**Tip:** If **Shortcut** is enabled, you can enable or disable the Audio Guide by pressing the \* four times in quick succession. (The \* button is located directly below the directional pad on the right side of the Roku remote.)

- ☒ **Speech rate** – Choose the speed at which the TV speaks Audio Guide prompts.
- ☒ **Volume** – Set the volume of the Audio Guide in relation to the main TV volume.
- ☒ **Shortcut** – Enable or disable the shortcut feature. When disabled, pressing \* four times in quick succession does not enable or disable the Audio Guide.



- ☒ **Closed captioning** – Controls when you see captions. *This setting is only offered for Antenna TV, the AV input, and streaming videos. Any set value remains in effect across only these inputs.*

  - **Antenna TV** – Set captions to off, always on, on only when the TV sound is muted, or on only during instant replay (when Live TV Pause has been enabled).
  - **AV input** – Set captions to off, always on, or on only when the TV sound is muted.
  - **Streaming video channel** – For streaming content that provides closed captions, set captions to off, always on, on only when the TV sound is muted, or on only during instant replay (for streaming content that supports instant replay). *Note that some streaming channels have other methods for turning captions on and off. In these cases, the **Closed captioning** option does not appear on the **Options** menu.*

**Note:** If the  button is not available on your remote, you can use this feature in the Roku mobile app. For more information, see [Getting and using the Roku mobile app](#).
- ☒ **Captioning track** – Selects which caption track to display when Closed Captioning is on. *This setting remains in effect on all inputs that provide captions.*
- ☒ **SAP** – Selects whether to play a secondary audio program or multichannel television sound, and which choice to play. *This setting applies only to Antenna TV on digital channels.*

## Video description through Secondary Audio Program (SAP)

Video description is audio descriptions of the action in a program, to help individuals who are blind or visually impaired enjoy the program. You enable video description by selecting one of the Secondary Audio Program (SAP) options.

To hear video description narrations in programs that have them, turn on **SAP**. If there are multiple **SAP** options for a channel, such as **Spanish** and **French**, try each one to determine which setting carries the video description track.

**Note:** Broadcasters provide video descriptions only on a small number of programs. If you are unable to hear video descriptions after following these instructions, the program you are viewing does not provide them.

For more details about video description, go to :

<https://www.fcc.gov/consumers/guides/video-description> .

## Advanced audio settings – DTS TruSurround (select models only)

This topic describes the **Advanced audio settings** menu for TV models with DTS TruSurround. Each TV input has separate settings for fine tuning sound quality. All of the settings in this menu apply only to the currently -selected input. To use the **Advanced audio settings** menu, first press **\*** to display the **Options** menu. Then select **Advanced audio settings**.



Advanced audio settings menu for models with DTS TruSurround

### Advanced audio settings menu options – DTS TruSurround

- ☒ **Audio effect** – Select from among various preset audio modes to improve speech, make music sound its best, boost bass or treble, or simulate a theater. Use **Reset audio settings**, described below, to return the input's current settings to their original values.

- ☒ **DTS TruSurround** – Simulates surround sound that otherwise would require installation of a surround sound audio system. Sometimes, the effect interferes with dialog clarity. Use the **Dialog Clarity** option to compensate.
- ☒ **Dialog Clarity** – Available only when **DTS TruSurround** is **On**. Choose among **Low**, **Medium**, and **High** settings to improve the clarity of dialog when you are using the **TruSurround** feature.
- ☒ **TruVolume** – Minimizes annoying volume fluctuations in programs.
- ☒ **Reset audio settings** – Returns **DTS TruSurround**, **Dialog Clarity**, and **TruVolume** settings, to their default settings for the selected **Audio effect**.

## Advanced audio settings – Sonic Emotion Premium (select models only)

This topic describes the **Advanced audio settings** menu for TV models with Sonic Emotion Premium. Sonic Emotion Premium is an audio technology that enables your TV to produce a more immersive sound experience. Each TV input has separate settings for fine tuning sound quality. All of the settings in this menu apply only to the currently -selected input. To use the **Advanced audio settings** menu, first press **\*** to display the **Options** menu. Then select **Advanced audio settings**.



Advanced audio settings menu for models with Sonic Emotion Premium

## Advanced audio settings menu options – Sonic Emotion Premium

- ☒ **Audio effect** – Select from among various preset audio modes to improve speech, make music sound its best, boost bass or treble, or simulate a theater. Use **Reset audio settings**, described below, to return the input's current settings to their original values.
- ☒ **Sonic Emotion Premium** – Displays a menu with individual Sonic Emotion audio settings, as described in [Sonic Emotion](#).
- ☒ **Reset audio settings** – Returns **Sonic emotion** settings to their default settings for the selected **Audio effect**.

## Sonic Emotion settings

When you turn on **Sonic Emotion** from the **Advanced audio settings** menu, these additional settings become available:



- ☒ **Dialog Enhancement** – Enhances your ability to hear and understand dialog in the program.
- ☒ **Bass Enhancement** – Enhances the low frequency sound component in the program.
- ☒ **Absolute 3D Sound** – Simulates sound from multiple speakers that would otherwise require installation of a surround sound audio system.

# Advanced picture settings

The **Advanced picture settings** menu for each TV input provides settings for fine tuning the appearance of the picture. All of the settings in this menu apply only to the currently -selected input.

To use the **Advanced picture settings** menu, first press **\*** to display the **Options** menu. Then select **Advanced picture settings**.



Typical Advanced picture settings menu

## Advanced picture settings menu options

- ☒ **Picture mode** – Provides picture presets for various viewing preferences. This setting duplicates the one on the **Options** menu. When you change the **Picture mode**, other picture settings adjust accordingly. For example, setting the **Picture mode** to **Vivid** sets **Brightness**, **Contrast**, **Sharpness**, and other values to produce a very vibrant picture. Setting **Picture mode** to **Movie** changes the settings to produce a picture suitable for enjoying movies in a darkened room. If you make changes to the individual picture settings—for example, **Contrast**, or **Sharpness**—these settings are saved for the current input and the current picture mode. In this way, you can set **HDMI 1** input's **Movie** picture mode to use different settings than the **HDMI 2** input's **Movie** picture mode and Antenna TV's **Movie** picture mode. Use **Reset picture settings**, described below, to return the input's selected picture mode to its original values.

- ☒ **Local contrast** – *Only on select models* : Sets the amount of dimming multiple “local” areas of the screen’s backlight intensity. This setting can make dark areas darker without affecting the brightness of light areas. *This option is disabled when **Game mode** is enabled .*
  
- ☒ **Dynamic contrast** – *Only on select models* : Automatically adjusts the backlight level to achieve the optimum contrast and prevent excessive differences between light and dark areas of the screen. *This option is disabled when **Local dimming/Local contrast** is enabled.*
  
- ☒ **Backlight** - Adjusts the overall light intensity of the screen. *On some models, this option is disabled when **Dynamic contrast** is enabled.*
  
- ☒ **Brightness** – Adjusts the dark level of the black areas of the picture.
  
- ☒ **Contrast** – Adjusts the white level of the light areas of the picture.
  
- ☒ **Sharpness** – Adjusts the sharpness of the edges of objects in the picture.
  
- ☒ **Color** – Adjusts the intensity of colors in the picture. A setting of 0 removes all color and displays a black and white picture.
  
- ☒ **Tint** – Adjusts the color balance from green to red to obtain accurate colors in the picture.
  
- ☒ **Color temperature** – Adjusts the overall colors in the picture from **Normal** to slightly more bluish ( **Cool**) to slightly more reddish ( **Warm**).
  
- ☒ **Action smoothing** – *Only on select models:* Adjusts the amount of action smoothing applied to the video signal. A higher setting results in more smoothing, but can cause undesirable picture artifacts in certain types of content . *Each **Picture mode** has a different **Action smoothing** default setting.*
  
- ☒ **Natural Cinema** – *Only on select models:* When enabled, this feature reduces “judder” that is often present when 24 frame-per-second movies are upscaled to 60Hz TV standards. **Natural Cinema** mode is **On** by default in **Movie** and **HDR Dark** picture modes, and **Off** by default in other picture modes. When **Natural Cinema** mode is **On**, **Action smoothing** is turned off and disabled.

- ☒ **Action clarity** – *Only on select 120Hz models:* Reduces blur, especially for fast moving images such as sports.
- ☒ **LED action clarity** – *Only on select models:* Reduces motion blur caused by LED backlight latency. Enabling this feature inserts black frames between picture frames in a way that improves the clarity of fast movement. It provides an improved viewing experience for video games and sporting events. When **LED action clarity** is enabled, the **Brightness** and **Dynamic contrast** settings are disabled. You can choose settings of **Low, Medium, High,** or **Off** to achieve the desired picture quality. Enabling **Game mode** sets **LED action clarity** to **Medium**.
- ☒ **Game mode** – *Only on HDMI \* and AV inputs:* Controls whether Game mode is enabled. When **On**, the TV performs less image processing and has less input lag. When **Off**, the TV performs more image processing and has more input lag, which is less desirable for action games.
- ☒ **Reset picture settings** – Returns all picture settings for the input's currently-selected **Picture mode** to their original values.

**Tip:** *To dismiss the **Advanced picture settings** menu, just wait a few seconds without pressing any buttons. Or press \* again to dismiss the menu immediately.*

## Expert Picture Settings (4K models only)

4K (UHD) TV models have additional picture settings for demanding home theater enthusiasts. Expert Picture Settings include gamma, noise reduction, 11 point white balance adjustment, and extended color management.

You can access Expert Picture Settings only by using the Roku Mobile App on an iOS or Android™ mobile device. For more information, go to the following link on the Roku web site:

[go.roku.com/expertpicturesettings](http://go.roku.com/expertpicturesettings)

# Changing privacy settings

**Note:** *Privacy settings are not present on TVs operating in non-connected mode.*

## Advertising

*Only in connected mode,* by default your TV uses an advertising identifier to track your TV usage. You can change the privacy settings on your TV in two ways: resetting the advertising identifier and limiting ad tracking.

### Reset the advertising identifier

Resetting the advertising identifier clears the prior usage history that your TV stores, and then begins tracking again. From that point forward, your new usage patterns affect the advertisements you see on your TV.

1. From the Home screen menu, navigate to **Settings > Privacy > Advertising**.
2. Highlight **Reset advertising identifier**. Press **\*** to view more information about this option. When you finishing reading the information, press **OK** to close the More Information window.
3. Press **OK** to reset the advertising identifier, and then press **OK** again to dismiss the verification message.

### Limit ad tracking

You can limit Roku's tracking of your usage behavior by limiting ad tracking. When you do, your TV will display ads that are not personalized based on your TV's advertising identifier.

1. From the Home screen menu, navigate to **Settings > Privacy > Advertising**.
2. Highlight **Limit ad tracking**. Press **\*** to view more information about this option. When you finish reading the information, press **OK** to close the More Information window.
3. Press **OK** to select the **Limit ad tracking** check box.

**Note:** *If you perform a factory reset and then reconnect your TV, ad tracking is restored until you repeat these steps.*



## Microphone

Your Roku TV does not have a built-in microphone. However streaming channel providers can use the microphone on the Roku voice remotes (only on select models) or on your mobile device when the Roku mobile app is running. You can control whether streaming channels have permission to use the microphone.

**Note:** *These settings affect only streaming channel access to the microphone. They do not affect your Roku TV's Voice Search feature.*

### Channel microphone access

You can control which streaming channels have permission to use the microphone, giving you control over how the microphone is used by each streaming channel. The default setting is Prompt, so no channel will be able to turn on the microphone without your permission.

To change microphone access settings:

1. From the Home screen menu, navigate to **Settings > Privacy > Microphone**.
2. Select **Channel microphone access**.
3. Choose one of the following settings:
  - ☒ **Prompt** – Display a notification each time any streaming channel requests the use of the microphone. When a notification appears, you can choose among **Prompt**, **Always allow**, and **Never allow** on a per-channel basis.
  - ☒ **Always allow** – Do not prompt, but always allow any streaming channel to use the microphone.
  - ☒ **Never allow** – Do not prompt, but never allow any streaming channel to use the microphone.

## Channel permissions

After granting or denying microphone access on a per channel basis, you can reset channel permissions to enable them to follow the system-wide setting you specify under [Channel microphone access](#).

To reset channel permissions:

1. From the Home screen menu, navigate to **Settings > Privacy > Microphone**.
2. Select **Channel permissions**.
3. Highlight **Reset channel permissions**, and then press **OK**.

# My Feed

*Only in connected mode,* use My Feed to find out when you can watch movies coming soon, and to get updates on movies, TV shows, and actors that you are following.

## Movies Coming Soon

My Feed gives you updates on your list of movies that are coming soon to theaters. With My Feed, you'll know when your favorite movie is ready to stream, the channels it is on, and how much it will cost.

Select the movies you want to follow by going to **My Feed > Movies Coming Soon**. You'll then see a list of newly released movies that are not yet available on Roku streaming devices. Select a movie, and then select **Follow this movie on Roku**. When you return to the main **My Feed** screen, you'll see banners for each of your newly followed movies along with banners for movies and TV shows you're already following.

## Movies, TV shows, and people

In addition to following movies coming soon, you can follow any movie, TV show, or actor across top streaming channels. To follow a program, use the Search feature to find the movie, TV show, or name that you want to follow, and then select **Follow this movie/TV show/person on Roku**. For more information, see [Searching for something to watch](#).

**Note:** *The TV takes a bit of time to update your newly followed shows. Until it finds at least one channel offering the movie, the content banner in My Feed shows **Check back later for updates**.*

My Feed alerts you any time a movie or TV show you are following becomes available on another channel and whenever its price changes. A number in parentheses next to

**My Feed** in the Home screen menu means that My Feed has updated information that you haven't viewed yet. For example, if three of your followed shows have updates, you'll see **My Feed (3)**.

**Note:** *When a movie or TV show you are following becomes available, the streaming channel offering the movie might require that you subscribe or pay a fee to view it.*

# Searching for something to watch

Searching for movies and shows across both Antenna TV ( *only in the United States* ) and streaming channels is one of the unique features of your Roku TV . Within a single search operation, you can search by:

- ☒ Movie name
- ☒ TV show name
- ☒ Actor or director name
- ☒ Streaming channel name
- ☒ Game name

**Note:** *Roku Search is not available if your TV is operating in non -connected mode. Roku Search doesn't search across all streaming channels, but searches across lots of popular streaming channels. The actual channels it searches vary by locale.*

## How do I search?

You can search by using an on -screen keyboard that you navigate using the arrow keys on your remote, or *only in the United States* , you can use a Roku voice remote or the Roku mobile app to search with your voice.

For more information about Voice Search , go to [go.roku.com/voicesearch](https://go.roku.com/voicesearch) .

## Keyboard search using the remote

1. Select **Search** on the Home screen menu.

The **Search** screen has a keyboard grid and initially displays instructions —a set of icons representing search categories and a list of participating provider tiles.

**Tip:** *If you don't see the instructions, navigate to the end of the list of recent searches and select **Clear recent search selections**.*



2. Use the arrow keys to navigate the on-screen keyboard, entering a few characters of the search term.

With each additional character you enter, you narrow down the search results, making the search results more relevant. You'll often see the results you are seeking after entering only a few letters.

3. When you see the show you are searching for, navigate to the right to highlight it.

## Voice Search from a Roku voice remote

*Only in the United States with models that have a Roku Voice Remote or Roku Enhanced Voice Remote :*

1. Press and hold the search button, either  or .
2. Say the name of a movie, TV show, actor, or director.

The TV lists the results of your search across many streaming and Antenna TV channels. An icon next to each search result shows the category of the result (movie, TV show, actor).

3. Press the **RIGHT** arrow to move the highlight into the list of search results.
4. Press the **UP** and **DOWN** arrows to scroll through the list of search results to highlight the item you want to view.

## Searching from the Roku mobile app

Use the free Roku mobile app on your compatible smartphone or tablet to make searching even faster. Use your mobile device's keypad to type more quickly and easily than with the on-screen keyboard on your TV. *Only in the United States*, you also can search simply by touching the Voice Search icon and saying the name of the movie, TV show, actor or director, streaming channel, or game.

When you use the Roku mobile app to search, search results are shown on your mobile device instead of on the TV screen. When you make a selection from the search results, the TV starts playing the selected program.

For more information, see [Getting and using the Roku mobile app](#).

## I found a show, now what?

Now that you've highlighted the show, movie, actor, game, or streaming channel you were looking for, press the **RIGHT** arrow.

If your search result was an actor, director, or other item that does not represent a single item of content, you'll see another list to narrow down your search. Continue highlighting results and pressing the **RIGHT** arrow until you find a single, viewable content item.



- ☒ The channel logo appears to the left of each result.
- ☒ *Only in the United States* , a **LIVE TV** logo indicates a program that is available on Antenna TV. Shows currently playing live appear at the top of the list. Shows airing in the future appear at the bottom of the list. Selecting a LIVE TV result switches the TV to that channel regardless of whether the program is currently in progress.
- ☒ An **HD** logo means that the content is available in high-definition.
- ☒ The checked circle adjacent to the title means you have already added the streaming channel.

If your search result was a game or a streaming channel, you'll see detailed information, images, and available actions, such as a list of streaming channels and the cost of getting the item or channel.

**Note:** *Some channels may require a paid subscription.*



## Follow on Roku

Rather than watch the show you found in Search, you can add it to My Feed and wait until it's available on a particular streaming channel or available at a better price. From the search results screen, select **Follow on Roku**. Then go to **My Feed** periodically to check for updates to each of your followed movies, TV shows, or people. For more information, see [My Feed](#).

## Recent Searches

The next time you use Roku Search, the **Search** screen displays a list of recent search selections in place of the search instructions.

Using the recent search selections list makes it easy to quickly get to a previously found item, for example, to find another movie with the same actor, or another TV show in the same series.

# Using the Roku Channel Store

*Only in connected mode*, the **Streaming Channels** menu option takes you to the Roku Channel store, where you can add new subscription based and free streaming channels to your TV.

**Tip:** You also can search for streaming channels by using the **Search** option, as explained in [Searching for something to watch](#).

To make it easier to find what you want, the streaming channels in the Roku Channel Store are categorized by topic. Press the **UP** and **DOWN** arrows to highlight the category you want, and then press the **RIGHT** arrow to move the highlight into the grid of streaming channel tiles.

When you find a streaming channel you want to add or learn more about, highlight it and press **OK** to display more details.

- ☒ If the streaming channel you are adding is free, you can select **Go to channel** to start watching it immediately.
- ☒ If there is a one-time or recurring fee associated with using the streaming channel, you must agree to the terms and conditions, accept the fee, and —if you created one when you activated your Roku TV, enter your Roku PIN code to authorize the charges.
- ☒ If you already have a subscription to the streaming channel —for example, you already subscribe to Netflix or you receive HBO through your cable TV provider —you must complete a different, simple authorization step to add the streaming channel.

You need only complete the authorization or activation step one time, when you initially add the streaming channel. After that, you simply select the streaming channel tile from your Home screen to start watching. (Channel and content availability is subject to change. Charges may apply to your selection. )

**Tip:** *New streaming channels are added continuously to the Roku Channel Store, so be sure to check back every now and then for new options.*

**Note:** *If you don't remember your PIN, or if you want to change whether you need to use a PIN to make purchases on your Roku account, see [Changing your Roku Channel Store PIN preference](#).*

# Customizing your TV

There are several things you can do to personalize your TV .

## Add TV inputs

As you use your TV, you might find that you need to add a TV input tile that you did not add during Guided Setup. To add a TV input:

1. From the Home screen menu, navigate to **Settings > TV inputs**. Notice that the list of inputs is divided into two sections: **Inputs being used** and **Inputs not used**.
2. Press the **UP** or **DOWN** arrows to highlight an input in the **Inputs not used** section of the list.
3. Press the **RIGHT** arrow to move the highlight to **Set up input**.
4. Press **OK** to add the input.
5. Press  to return to the Home screen. Notice that the input has been added to the top of the Home screen . If you want to move the input tile to a different position in the grid, see [Rearrange tiles](#) .

## Add streaming channels

You can add streaming channels by searching in the Roku Channel Store. New streaming channels are added to the bottom of the Home screen. If you want to move the channel tile to a different position in the grid, see [Rearrange tiles](#) .

# Rename inputs

Rather than trying to remember that your Blu-ray™ player is connected to **HDMI 1** and your game console is connected to **HDMI 3**, you can rename the TV inputs to match the connected device .

**Note:** *Renaming an input also changes the icon associated with it.*

To rename an input, you can either:

- ☒ Highlight the input tile in the Home screen, and then press **\*** to display a list of options. From the list of options, select **Rename input**. Then select a new name and icon.

or

- ☒ From the Home screen, navigate to **Settings > TV inputs**. On the **TV inputs** screen, select the input you want to rename, select **Rename**, and then choose a new name and icon from the provided list.

Rather than using the predefined names and icons , you can set a custom name and icon. To do so, scroll up or down to highlight **Set custom name & icon**, and then press **OK**. Follow the instructions on the screen to enter a name and select an icon for the input.

Press  to return to the Home screen. The new name and icon are now in effect.

## Remove unwanted tiles

It's easy to remove unused TV inputs and unwanted channel or app tiles. For example, if you never use the **HDMI 3** input, or if you don't like the weather app you added from the Roku Channel Store, you can remove them from your Home screen.

**Note:** You also can remove the **Antenna TV** tile if you never use the TV tuner. But be aware that removing the Antenna TV tile also deletes the channel list. You'll have to set up the TV tuner again next time you want to view Antenna TV. Instructions for setting up the TV tuner can be found in [Setting up Antenna TV](#).

- ☒ To remove any tile, highlight the input tile in the Home screen, and then press **\*** to display a list of options. From the list of options, select **Remove input**. In the screen that follows, confirm you want to remove the input.
- ☒ Alternatively, to remove a TV input tile from the Home screen, navigate to **Settings > TV inputs**. On the **TV inputs** screen, select the input you want to remove, and then select **Remove > Confirm**. Then press  to return to the Home screen.

# Rearrange tiles

When you add a TV input tile, it's added at the top of your Home screen. When you add a new streaming channel, it's added at the bottom of your Home screen.

You can easily rearrange the order of the tiles on the Home screen to suit your viewing preferences. For example, you might want **Antenna TV** to be the first tile in your Home screen. But if you mostly watch one streaming channel, you might want its tile to be the first one on your Home screen.

1. From the Home screen, highlight one of the tiles you want to move.
2. Press **\*** to display a list of options for the type of tile you selected.
3. Select **Move input** or **Move channel**. The list of options disappears and the highlighted tile shows arrows indicating how it can be moved.

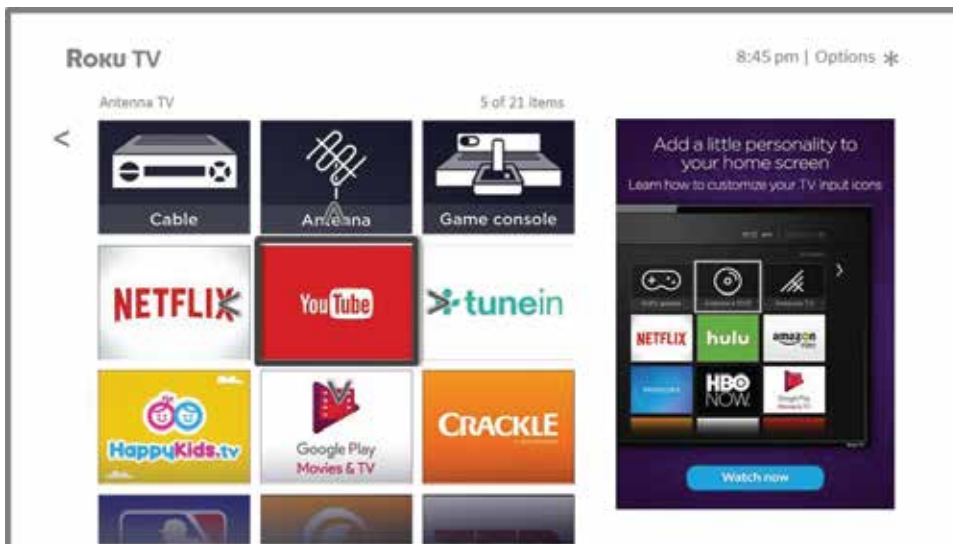

**Note:** A paid subscription or other payments may be required for some channels. Channel availability is subject to change and varies by country. Not all content is available in countries or regions where Roku products are sold.

4. Use the arrow keys to move the highlighted tile to its new position. As you move the tile, it pushes other tiles out of its way.
5. Press **OK** to lock the tile into its new position.
6. Repeat these steps to move other tiles until you have arranged your Home screen to your liking.

## Change themes

*Only in connected mode*, another way to customize your TV is to change its theme.

The theme establishes the look and feel of the TV through colors, designs, and fonts.

Some themes require payment.

To change the theme, in the Home screen menu navigate to **Settings > Themes**. In the **Themes** screen, choose from the following options:

- ☒ **My themes** – Highlight a theme, and then press **OK** to switch to that theme.
- ☒ **Get more themes** – Highlight this option at the bottom of the **My Themes** list, and then press **OK** to shop for new themes.
- ☒ **Custom settings** – Turn **Featured themes** on or off. When **Featured themes** is on, the TV automatically switches to featured themes —like certain holiday-inspired themes —for a limited time whenever Roku makes them available, and then switches back to your selected theme when the featured theme expires. When off, the TV uses your selected theme.

## Edit Antenna TV channel lineup

When you set up the TV tuner as described in [Setting up Antenna TV](#), the TV adds all the channels with good signals that it can detect in your area. It's likely that you now have more channels than you want in your channel list.

To edit the channel lineup, from the Home screen, navigate to **Settings > TV inputs > Antenna TV > Edit channel lineup**. You'll see a screen listing all of your channels. Adjacent to the list of channels is a miniature TV screen playing the highlighted channel's picture and sound.





Highlight each channel you want to hide, and then press **OK** to hide the channel.

**Tip:** *If you need to see or hear the highlighted channel, wait a couple of seconds for the TV to start playing the channel's picture and sound. Also note that if you've enabled parental controls and the program on the current channel is blocked, you won't see a picture or hear sound while editing the channel lineup.*

**Note:** *Repeating the tuner channel scan unhides all hidden channels.*

## Change menu volume

Menu sounds are the noises the TV makes to let you know it received your command. You can change the volume of these menu sounds or turn them off.

To adjust the menu volume, in the Home screen menu, navigate to **Settings > Audio > Menu volume**. Navigate to the right and then change the setting to **High, Medium, Low, or Off**.

# Configure power settings

Power settings let you configure features related to how your TV's power settings work.

## Power on settings

Power on settings tell the TV what to do when you turn on the power. To configure the power on settings, from the Home screen, navigate to **Settings > System > Power > Power on**. Highlight the preferred power on location in the list, and then press **OK**.

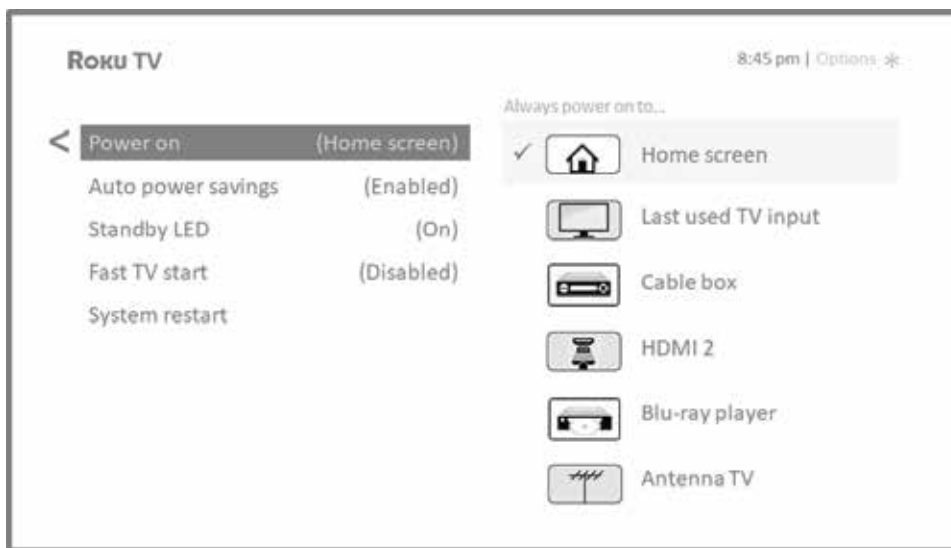

## Auto power savings

To help you save energy, your TV can automatically turn itself off after a period of inactivity or a period during which no signal has been detected. It is factory configured to do both of these things, but you can change these settings if needed.

To configure automatic power off, from the Home screen menu navigate to **Settings > System > Power > Auto power savings**. In the **Power settings** screen, highlight the following options and press **OK** to turn them on or off:

- ☒ **Reduce power after 15 minutes** – If no video or audio activity and no user interaction occur for 15 minutes, the TV automatically turns off the screen and sound.
- ☒ **Turn off after 4 hours** – If no video or audio activity and no user interaction occur for 4 hours, the TV goes into standby mode.

## Standby LED On/Off

Normally, the status indicator is lit whenever the TV is in standby mode. If you prefer the status indicator to not be lit in standby mode, you can turn it off. To do so, from the Home screen, navigate to **Settings > System > Power > Standby LED**, and then select **Off**.

After making this change, the status indicator still performs all other indication functions.

## Fast TV start

*Only in connected mode on TV models that are not Energy Star certified*, you can enable **Fast TV start**. As you might expect, **Fast TV start** lets you start watching your TV almost instantly after turning it on. But it also enables other convenient features, such as the ability to turn on your TV using voice commands or the Roku mobile app.

Be aware that enabling Fast TV start makes your TV use somewhat more power when it is powered off to standby mode.

## Configure accessibility (U.S. only)

Accessibility settings enable users with vision or hearing impairment to use the TV more effectively. Accessibility settings are located under **Settings > Accessibility**.

### Captions mode

The **Captions mode** settings specify when closed captions appear. Access caption settings from the Home screen by selecting **Settings > Accessibility > Captions mode**. At this point, you can choose among the following options:

- Off** – No captions appear.
- On always**– Captions appear whenever they are available from the program source.
- On replay**– Captions appear only when you use the replay feature, and only when you are watching a streaming program that supports instant replay or watching a TV channel after enabling Live TV Pause.

- ☒ **On mute** – Captions appear only when the TV is muted.

### Tips:

- ☒ *You can change the captions mode while watching a program. Press \* to display the **Options** menu, and then select **Closed Captioning**.*
- ☒ *Some streaming channels require you to enable captions through a setting within their channel even though you have turned on captions in the TV settings .*

**Note:** Once enabled, the selected captions mode applies to all inputs that support captions and remains enabled until you turn it off.

## Captions preferred language

The **Captions preferred language** setting lets you select the language in which you want closed captioning to appear, when that language is available. If your preferred language is not available, then captioning reverts to the default language for the program, which usually is English.

Highlight the language you prefer, and then press **OK** to select it.

## Captions style

The **Captions style** settings let you control how closed captions look when displayed on your TV. Access caption style settings from the **Home** screen by selecting **Settings > Accessibility > Captions style**. At this point, you can choose among the following options:

- ☒ **Text style** – Choose from a list of fonts. As you move the highlight to each font, you can see a sample of the result in an adjacent panel.
- ☒ **Text edge effect** – Choose from a list of edge effect styles, such as raised, depressed, and various shadows. As you move the highlight to each effect, you can see a sample of the result in an adjacent panel.
- ☒ **Text size** – Choose from a list of sizes. As you move the highlight to each size, you can see a sample of the result in an adjacent panel.

- ☒ **Text color** - Choose from a list of colors for the text. As you move the highlight to each color, you can see a sample of the result in an adjacent panel.
- ☒ **Text opacity** - Choose from a list of opacity settings for the text. This setting determines how much the area behind the text shows through the text. A value of 100% blocks all of the content behind the text. As you move the highlight to each setting, you can see a sample of the result in an adjacent panel.
- ☒ **Background color** - Choose from a list of colors for the background area behind the text. As you move the highlight to each color, you can see a sample of the result in an adjacent panel. Note that you won't see any change unless you set the **Background opacity** to a value other than **Off**.
- ☒ **Background opacity** - Choose from a list of opacity settings for the background of the caption. This setting determines how much the area behind the caption background shows through the background. A value of 100% blocks all of the content behind the background. As you move the highlight to each setting, you can see a sample of the result in an adjacent panel.
- ☒ **Window color** - Choose from a list of colors for the window rectangle surrounding the entire caption. As you move the highlight to each color, you can see a sample of the result in an adjacent panel. Note that you won't see any change unless you set the **Window opacity** to a value other than **Default** or **Off**.
- ☒ **Window opacity** - Choose from a list of opacity settings for the window rectangle surrounding the entire caption. This setting determines how much the area behind the caption window shows through the window. A value of 100% blocks all of the content behind the window. As you move the highlight to each setting, you can see a sample of the result in an adjacent panel.

## Audio Guide settings

Audio Guide settings help users who are blind or visually impaired to configure the text-to-speech reader, enabling them to operate their TV more easily. Audio Guide uses voice prompts that speak volume and channel changes, menu options, and setting changes. Access Audio Guide settings from the **Home** screen by navigating to **Settings > Accessibility**, and then select from the following options in the **Audio Guide** section:

- ☒ **Audio Guide** – Turn Audio Guide on or off.
- ☒ **Speech rate** – Select one of four speeds at which to hear spoken guide information : **Slow, Normal, Fast, or Very Fast.**
- ☒ **Volume** – Select the volume at which to hear spoken guide information, relative to the main TV volume.
- ☒ **Shortcut** – Enable or disable the shortcut feature. When enabled (the default), pressing **\* four times in quick succession** on enables or disables the Audio Guide.

## Changing caption settings (Canada only)

On models sold in the United States, you can find caption settings under **Settings > Accessibility > Captions mode** and **Captions style**. On models sold in Canada, you can find captions settings under **Settings > Captions**.

### Captions mode

- ☒ **Off** – No captions appear.
- ☒ **On** – Captions appear whenever they are available from the program source.
- ☒ **Instant replay** – Captions appear only when you use the replay option, and only when you are watching a streaming program that supports instant replay.
- ☒ **When mute** – Captions appear only when the TV is muted.

### Tips

- ☒ *You can change the captions mode while watching a program. Press **\*** to display the **Options** menu, and then select **Closed Captioning**.*
- ☒ *Some streaming channels require you to enable captions through a setting within their channel even though you have turned on captions everywhere else.*

**Note:** *Once enabled, the captions mode applies to all inputs that support captions and remains enabled until you turn it off.*

### Captions preferred language

Choose the language in which you want closed captioning to appear, when that language is available. If your preferred language is not available, then captioning reverts to the default language for the program, which usually is English.

Highlight the language you prefer, and then press **OK** to select it.

## Other caption settings

- ☒ **Text style** – Choose from a list of fonts. As you move the highlight to each font, you can see a sample of the result in an adjacent panel.
- ☒ **Text edge effect** – Choose from a list of edge effect styles, such as raised, depressed, and various shadows. As you move the highlight to each effect, you can see a sample of the result in an adjacent panel.
- ☒ **Text size** – Choose from a list of sizes. As you move the highlight to each size, you can see a sample of the result in an adjacent panel.
- ☒ **Text color** - Choose from a list of colors for the text. As you move the highlight to each color, you can see a sample of the result in an adjacent panel.
- ☒ **Text opacity** - Choose from a list of opacity settings for the text. This setting determines how much the area behind the text shows through the text. A value of 100% blocks all of the content behind the text. As you move the highlight to each setting, you can see a sample of the result in an adjacent panel.
- ☒ **Background color** - Choose from a list of colors for the background area behind the text. As you move the highlight to each color, you can see a sample of the result in an adjacent panel. Note that you won't see any change unless you set the **Background opacity** to a value other than **Off**.
- ☒ **Background opacity** - Choose from a list of opacity settings for the background of the caption. This setting determines how much the area behind the caption background shows through the background. A value of 100% blocks all of the content behind the background. As you move the highlight to each setting, you can see a sample of the result in an adjacent panel.
- ☒ **Window color** - Choose from a list of colors for the window rectangle surrounding the entire caption. As you move the highlight to each color, you can see a sample of the result in an adjacent panel. Note that you won't see any change unless you set the **Window opacity** to a value other than **Default** or **Off**.
- ☒ **Window opacity** - Choose from a list of opacity settings for the window rectangle surrounding the entire caption. This setting determines how much the area behind the caption window shows through the window. A value of 100% blocks all of the content behind the window. As you move the highlight to each setting, you can see a sample of the result in an adjacent panel.



# Configuring parental controls

Parental controls enable you to control whether the members of your household can view certain kinds of broadcast TV programs. When a program or feature is blocked, you can unblock it by entering a parental control PIN that only you know.

**Note:** *Parental controls block content from the TV tuner and from streaming options, if any, on the Home screen menu . Parental controls do not block content on other TV inputs or content from streaming channels you add to your TV.*

## Creating a parental control PIN

The first time you access the **Parental controls** screen, you must create a new parental control PIN. Thereafter , whenever you want to change parental control settings, unblock programming that has been blocked, change the PIN, or disable parental controls, you must enter your parental control PIN.

**Tip:** *Your parental control PIN has nothing to do with your Roku PIN. You can make them the same if you want —this is entirely your choice.*

To create a new parental control PIN, from the Home screen menu navigate to **Settings > Parental controls**. The screen displays a numeric keypad. Use the arrow keys and then press **OK** to enter a four digit code. Then repeat the process to enter the same PIN again, just to make sure you correctly entered the PIN you want to use.

**Important:** *If you forget your parental control PIN, the only way to recover is to perform a factory reset operation , as explained in [Factory reset everything](#) . Be sure to write it down in a safe place just in case.*

## Blocking Movie Store, TV Store, and News (U.S. only)

One of the parental control options is to completely hide the entertainment options that are available directly on the Home screen menu.

To hide Home screen entertainment options:

1. From the Home screen menu, navigate to **Settings > Parental controls**, and then enter your parental control PIN.
2. In the **Parental controls** screen, highlight Home screen and then select or clear either of these options:
  - Hide “Movie Store and TV Store”** – Removes the **Movie Store** and **TV Store** options from the Home screen menu.
  - Hide “News”** – Removes the **News** option from the Home screen menu.

**Tip:** To use either of these options after you’ve hidden them, you must return to this screen and remove the check mark from the corresponding **Hide** command.

## Blocking Broadcast TV shows

For broadcast TV, parental controls use information embedded in the broadcast signal to determine whether to allow a program to be displayed. Parents can configure parental controls to block broadcast TV programs that meet or exceed a specific rating, so they cannot be viewed or heard unless the correct parental control PIN is entered.

**Note:** *Rating standards differ by country.*

### Enabling parental control of TV shows

The first step in blocking TV shows is to enable parental control of TV shows.

This setting is provided separately to make it easier for you to turn parental control of TV shows on and off without disturbing their settings. For example, your kids are going to summer camp for two weeks, and while they are gone, you don’t want to have to deal with unblocking shows that you want to watch by entering your parental control PIN. All you need to do is clear **Enable parental controls**, and all TV shows are unblocked. When the kids return, select **Enable parental controls** again, and all of your parental control settings are restored in a single operation.

To enable parental control of TV shows:

1. In the Home screen menu, navigate to **Settings > Parental controls**, and then enter your parental control PIN.
2. In the **Parental controls** screen, navigate to **TV tuner > Parental control of TV shows**.
3. Make sure the check box next to **Enable parental controls** is checked. If not, highlight it and press **OK**.

### Blocking based on US TV ratings

Most broadcast US TV shows —other than movies —contain rating data that enables parental controls to block shows that parents don't want others to view. The ratings are divided into two groups that function independently:

- ☒ **Youth group** – TV -Y, TV -Y7
- ☒ **Main group** – TV -G, TV -PG, TV -14, TV -MA

Within each of these groups, the ratings interact such that if you block a particular level of content, the TV also blocks all content with a higher rating. Conversely, if you unblock a particular level of content, the TV also unblocks all content with a lower rating. For example, if you block TV -PG programs, the TV also blocks TV -14 and TV -MA programs. If you subsequently unblock TV -14 programs, TV -PG programs are also unblocked, but TV -MA programs remain blocked.

Similarly, within the main group, content types can be individually blocked. For example, you can block just coarse language in shows with a TV -PG rating. If you do, then the TV also blocks shows with coarse language in the higher ratings (TV -14 and TV -MA). Subsequently unblocking coarse language in TV -14 ratings does not unblock coarse language in TV -MA programs, but it does unblock coarse language in TV -PG programs.

To block TV shows based on US television ratings:

1. From the Home screen menu, navigate to **Settings > Parental controls**, and then enter your parental control PIN.
2. In the **Parental controls** screen, navigate to **TV tuner > TV ratings**. Choose among the following settings:
  - ☒ **Entire ratings** – Highlight the rating you want to block, and then navigate to the right and select the first option that blocks the entire rating level (and all higher rating levels).
  - ☒ **Individual content types** – Highlight the rating that contains the content type you want to block, and then select the content types you want to block from among those listed. Remember that blocking a content type in one rating blocks the equivalent content type in all higher rating levels.

## Blocking based on US movie ratings

Most movies in the US are rated by the Motion Picture Association of America, or MPAA, so the ratings are known as MPAA ratings. TV broadcast signals carry movie rating data that enables parental controls to block shows that parents don't want others to see. The ratings are:

- ☒ G – General audiences
- ☒ PG – Parental guidance suggested
- ☒ PG - 13 – Parents strongly cautioned for children age 13 or younger
- ☒ R – Restricted
- ☒ NC - 17 – Not for age 17 or younger

Unlike US TV ratings, there are no individual content types within the ratings. But like TV ratings, blocking movies with a particular rating also blocks movies with a higher rating, and unblocking movies with a particular rating also unblocks movies with a lower rating.

**Tip:** *Blocking movies with an NC - 17 rating also blocks programs with the now obsolete X rating, which can still occur in the program data of older movies.*

To block movies based on MPAA ratings:

1. From the Home screen menu, navigate to **Settings > Parental controls**, and then enter your parental control PIN.
2. In the **Parental controls** screen, navigate to **TV Tuner > Movie ratings**.
3. Select the rating level you want to block. You need only select one rating level, and all higher levels are automatically blocked.

## Blocking based on Other ratings

Your TV can block programs having ratings that had not been defined when the TV was manufactured. It does this by detecting a new Rating Region Table in a program and then downloading the new table and displaying its rating in the Parental controls.

When the TV downloads a new Rating Region Table, it adds a new option to the list of rating types: **Other ratings**. If you see this option in the **Parental controls** screen, you have tuned to a station that has implemented a new rating table. Once the new rating table has been downloaded to the TV, it remains in the TV until it is factory reset, and you can configure blocking based on the new ratings.

New Region Rating Tables can have independent rating levels, or rating levels that interact in the same ways as the built-in US TV and MPAA Movie ratings.

**Tip:** *If your TV downloads a new Region Rating Table, you'll have to experiment with its settings to understand how to use it.*

## Blocking based on Canadian English ratings

Canadian -English language and third -language programs that are broadcast in Canada are rated by the Action Group on Violence on Television, or AGVOT. TV broadcast signals carry rating data that enables parental controls to block shows that parents don't want others to view based on content containing violence, language, sex, or nudity. The ratings are:

- ☒ C – Children under 8 years
- ☒ C8 – Children 8 years and older
- ☒ G – Generally suitable for all age groups
- ☒ PG – Parental guidance suggested for viewers under 14 years
- ☒ 14+ – Generally not suitable for viewers under 14 years
- ☒ 18+ – Generally not suitable for viewers under 18 years

Blocking content with a particular rating also blocks content with a higher rating, and unblocking content with a particular rating also unblocks movies with a lower rating.

To block programs based on AGVOT ratings:

1. From the Home screen menu, navigate to **Settings > Parental controls**, and then enter your parental control PIN.
2. In the **Parental controls** screen, navigate to **TV tuner > Canadian English ratings**.
3. Select the rating level you want to block. You need only select one rating level, and all higher levels are automatically blocked.

### Blocking based on Canadian French ratings

Canadian -French language programs that are broadcast in Canada are rated by the Régie du cinéma du Québec. TV broadcast signals carry rating data that enables parental controls to block shows that parents don't want others to view based on content containing violence, language, sex, or nudity. The ratings are:

- ☒ G – Generally suitable for all age groups
- ☒ 8+ – Viewers 8 years and older
- ☒ 13+ – Viewers 13 years and older
- ☒ 16+ – Viewers 16 years and older
- ☒ 18+ – Adults only

Blocking content with a particular rating also blocks content with a higher rating, and unblocking content with a particular rating also unblocks movies with a lower rating.

To block programs based on Canadian -French ratings:

1. From the Home screen menu, navigate to **Settings > Parental controls**, and then enter your parental control PIN.
2. In the **Parental controls** screen, navigate to **TV tuner > Canadian French ratings**.
3. Select the rating level you want to block. You need only select one rating level, and all higher levels are automatically blocked.

## Blocking unrated programs

Some broadcast TV shows and movies do not have an assigned rating, and are considered to be “Unrated”. Whether or not such programs contain content that is objectionable to you cannot be determined. However, you can choose to block such programs.

To block all unrated broadcasts:

1. From the Home screen menu, navigate to **Settings > Parental controls**, and then enter your parental control PIN.
2. In the **Parental controls** screen, navigate to **TV tuner > Block all unrated programs**.
3. Highlight **Unrated programs** and press **OK**. When blocking is enabled, the adjacent padlock icon changes from unlocked to locked.

**Tip:** *Blocking programs that have not been assigned a rating does not block programs that specifically have been assigned a US TV rating of “None” (for example a broadcast of a local town council meeting). Programs that do not have an assigned rating display **Rating NA** (for “not applicable,” meaning a rating is not needed).*

*In the absence of other ratings for a program, the parental controls do not consider the MPAA US movie rating **N/A** (MPAA rating not applicable to this content) and **NR** (applicable content not rated by the MPAA) to be ratings. In these cases, the TV handles the program as though it is unrated, blocking the program if **Unrated programs** blocking is enabled.*

## What happens when a TV show is blocked?

After you've set up parental controls, TV shows and movies can be blocked:

- ☒ When you change channels and the new channel is playing a program whose rating exceeds your settings.
- ☒ When a new show comes on the channel you are watching and its rating exceeds your settings.

When a program is blocked by parental control settings, the TV displays a blocked message:



Whenever this blocked message appears, both the video and audio of the show are blocked, as well as program data that would normally appear in the area at the bottom of the screen.



To watch the blocked program, you need to know the PIN code defined when you enabled parental controls, as explained in [Creating a parental control PIN](#).

1. Press **OK** to select **Unblock** and display a PIN pad.



2. Use the arrow keys to enter your parental control PIN code, and then press **OK** to select **Unblock everything**.

After unblocking shows that have been blocked, all blocking is disabled for two hours or until you turn off the TV.

## Changing the parental control PIN

To change your parental control PIN:

1. From the Home screen menu, navigate to **Settings > Parental controls**, and then enter your parental control PIN.
2. In the **Parental controls** screen, highlight **Change PIN**.
3. Move the highlight into the adjacent keypad, and then use the arrow keys and then press **OK** to enter a four digit code. Then repeat the process to enter the same PIN again, just to make sure you correctly entered the PIN you want to use.

## Resetting parental controls

So now your kids have grown up and gone away to college, and you no longer want to deal with blocked programs.

To erase all parental control settings:

1. From the Home screen menu, navigate to **Settings > Parental controls**, and then enter your parental control PIN.
2. In the **Parental controls** screen, highlight **Reset parental controls**.
3. Follow the instructions on the screen to confirm that you want to erase all parental control settings.

**Tip:** *Resetting parental controls also erases your parental control PIN.*

# More settings

This section describes the features and settings of the TV that were not covered in the other parts of this guide.

## Changing network settings

If needed, you can change your network settings at any time. For example, if you change the name of your wireless network (its SSID) or its password, you will need to change your TV's settings so that it can continue to connect. Also, if you decided not to connect to the Internet in [Guided Setup](#), you can use network settings to connect at a later time.

To change network settings, from the Home screen menu, navigate to **Settings > Network**, and then press the **RIGHT** arrow. At this point, you can choose the following options:

- ☒ **About** – Lists important information about your current network connection, such as status, connection type, IP addresses, and MAC address. This information is often useful when contacting customer support with connection issues.
- ☒ **Check connection** – Select your existing network connection type, and then press **OK** to start checking the network connection. The TV uses your current network information to reconfirm the wireless or wired network connection to the local network and the Internet connection.
- ☒ **Set up connection** – Select a network connection type, and then select the option to set up a new connection. Follow the on-screen instructions to complete the network connection. For help with each of the steps, see [Network connection](#).

**Note:** Some networks, such as those found in dorm rooms, hotels, and other public places, may require you to read and agree to terms, enter a code, or provide identifying information before letting you connect to the Internet. For more information, see [Using your TV in a hotel or dorm room](#).

## Changing ZIP Code

Only in connected mode, your TV needs to know your ZIP Code so that it can display the correct channels and program guide information. It attempts to determine your ZIP Code by using information from your Internet connection; however, the information available from this source is not always accurate. To ensure you have the most accurate program guide information, use the ZIP Code option to enter your correct ZIP Code.

To set your correct ZIP code, from the Home screen menu, navigate to Settings > System > ZIP Code, and then pressing the RIGHT arrow. Use the on-screen number pad to select each of the digits of your ZIP Code, and then select OK.

## Changing time settings

You can change time settings to suit your preferences. You can find the following settings by navigating from the Home screen menu to **Settings > System > Time:**

- ☒ **Sleep timer** – Set a time delay after which the TV will automatically shut off. This setting reflects the setting you can make in the **Options** menu from any TV input, as explained in [Options menu settings](#). *Note that the sleep timer setting is not input specific.*
- ☒ **Time zone** – Select whether to set the time zone automatically or manually, and if set manually, select your current time zone. Typically, a TV connected to the Internet can discover its own time zone automatically, and a TV that is not connected to the Internet must be set manually. Initially, this setting is made when you set up the TV tuner, as explained in [Setting up Antenna TV](#). Correct time zone information is needed to correctly display program data.
- ☒ **Clock format** – Select whether to display time in a 12-hour or 24-hour format, or to turn off time display. *This setting is available only on TVs that are connected to the Internet. Non-connected TVs do not display the time.*

## Scanning for Antenna TV channels again

There will be times when you need to create a new channel list. For example, you:

- ☒ Change cable providers
- ☒ Reorient your TV antenna
- ☒ Move to a different city with different channels

Whenever you need to update your TV channel list, you can repeat the channel scan.

**Tip:** Repeat the channel scan from time to time to make sure you are receiving all of the latest channels. Broadcasters add and remove channels, move channels to different parts of the spectrum, and change the power levels of their channels periodically.

**Note:** Repeating the tuner channel scan unhides all hidden channels.

To repeat the channel scan, from the Home screen menu, navigate to **Settings > TV inputs > Antenna TV > Scan again for channels**. Then select **Start finding channels** to begin the channel scan process. The screens and options that appear during this process are identical to those described in [How do I set up the TV tuner?](#)

## Setting the HDMI<sup>®</sup> mode (4K models only)

On 4K (UHD) TVs, you can independently configure each HDMI<sup>®</sup> input to match the capabilities of the connected device. From the Home screen menu, navigate to **Settings > TV inputs**, and then select an enabled HDMI<sup>®</sup> input. Next, select **HDMI mode** and then select one of the following settings:

- ☒ **Auto** – Let the TV determine the best setting. Use this option unless your HDMI<sup>®</sup> device does not correctly communicate its HDMI<sup>®</sup> version compatibility.
- ☒ **HDMI 1.4** – Configure the input for compatibility with HDMI<sup>®</sup> version 1.4, which supports a maximum refresh rate of 30 Hz at full UHD resolution. Most HDMI<sup>®</sup> devices will work correctly with the TV in this mode.
- ☒ **HDMI 2.0** – Configure the input for compatibility with HDMI<sup>®</sup> version 2.0, which supports a maximum refresh rate of 60 Hz at full UHD resolution. You must use

this mode to view HDR content from the device connected to this HDMI input. However, note that many older HDMI devices do not work correctly when the TV's HDMI input is set to this mode.

## Adjusting external device connections

You can choose the level of control you want to allow your TV to accept from external devices, such as smart phones, tablets, and virtual assistants. Device connect settings enable other devices, including the Roku Mobile App, to control your TV over the local area network in your home.

To adjust the level of external control access:

1. From the Home screen menu, navigate to **Settings > System > Advanced system settings > Control by mobile apps**.
2. Select **Network access**.
3. Choose one of the following settings:
  - Default** – Devices can connect only through a private network address, and accept commands only from other private network addresses on your home network. This setting is suitable for most cases, including use of the Roku mobile app on your smartphone.
  - Permissive** – Devices can connect under all conditions, but accept commands only from private network addresses or the same subnet within your home network. This setting might be required when attempting to operate the TV from a third-party application, for example, one of the Internet of Things (IoT) applications such as ifttt.com.
  - Disabled** – Device connection is completely disabled. The TV does not accept external commands from any source, including the Roku mobile app.

## Using the TV in a home theater

Your TV has several features that make it an ideal TV for a home theater. But you might not notice them because they remain in the background until you decide to use them.

### Turning off the speakers

When you use your TV with a sound bar or an external amplifier and speakers, you'll probably want to turn off the internal TV speakers.

To turn off the TV's built-in speakers, in the Home screen menu, navigate to **Settings > Audio > TV speakers** and change the setting.

**Tip:** *The TV's internal speakers can be enabled and disabled automatically as needed by system audio control, as described in [Enable system audio control](#). Using the headphone jack also turns off the internal speakers.*

## Setting up a digital audio connection

To take advantage of your TV's advanced audio capabilities, connect it to an external amplifier, receiver, or sound bar by using either of these two digital audio connections:

- ☒ **HDMI ARC** – The HDMI® Audio Return Channel enables the TV to output digital audio on one of its HDMI® connectors. The connected amplifier can also function simultaneously as an input source to the TV, if needed. To use the ARC capability, you must connect an HDMI® cable from your amplifier's HDMI® ARC connector to the **HDMI ARC** connector on the TV. You also must:



- Be sure your HDMI® cable is certified by HDMI®.
- Enable **HDMI ARC** under **Settings > System > Control other devices (CEC)**, as explained in [Enable HDMI® ARC](#).

- ☒ **SPDIF optical** – The SPDIF optical connector outputs a digital audio signal. To use the optical output, connect a TOSLINK optical cable from the amplifier to the Optical or SPDIF connector on the TV.



**Note:** *Dolby Audio™ supporting Dolby Digital Plus™ format is not available through the SPDIF optical output. This format is only available through the HDMI® ARC connection.*

After making the required HDMI® ARC or SPDIF optical connection, go to **Settings > Audio > S/PDIF and ARC** option and select the audio format to use.

**Note:** *In most cases, **Auto detect** is the best option. Other settings can result in no sound when the content you are viewing does not contain the audio stream type you selected.*



## Controlling other devices through CEC

Consumer Electronics Control (CEC) enables your TV and other CEC-compatible home entertainment devices to control one another in various ways. First, the CEC-compatible devices must “discover” one another and report their capabilities. After this, one device can control another according to the features you enable. For example, playing a disc on a Blu-ray™ player could switch the TV to the Blu-ray™ player’s input. Or, powering off the TV could also power off the Blu-ray™ player and the home theater receiver.

### Discover connected CEC devices

To discover CEC devices:

1. Make sure that your CEC-compatible devices are connected to the TV with a suitable High Speed HDMI® Cable that supports HDMI® ARC and CEC control.
2. Turn on each device and make sure all devices are CEC enabled.

**Tip:** *Some manufacturers have their own branded names for CEC functionality, so you might need to read the product documentation to correctly identify the CEC features of the device.*

3. On the TV’s Home screen menu, navigate to **Settings > System > Control other devices (CEC)** and then select **Search for CEC devices**. Press **OK** to repeat the discovery process, if necessary.

When finished, the TV displays a list of CEC devices that are connected to each HDMI® input, as well as any devices that had previously been connected. The TV remembers the names of multiple CEC devices even when they are no longer connected. If the list is longer than the allowed space, press **\*** to see a complete list in a scrollable window.

### Enable HDMI® ARC

HDMI® ARC is the audio return channel that is available on one of the TV’s HDMI® ports. The audio return channel enables you to send a Dolby Audio™ signal back to a home theater receiver that is also sending an audio and video signal in to the TV. Using HDMI® ARC reduces the number of cables needed and optionally lets you control the volume and mute state of the receiver by enabling system audio control.

HDMI<sup>®</sup> ARC is disabled by default. To enable HDMI<sup>®</sup> ARC, in the Home screen menu, navigate to **Settings > System > Control other devices (CEC)**, and then highlight **HDMI ARC**. Press **OK** to enable or disable the feature.

**Note:** *Enabling **HDMI ARC** also enables **System audio control**. After enabling **HDMI ARC**, you can disable **System audio control** if you prefer.*

## Enable system audio control

System audio control enables the TV remote to change the volume and mute state of an amplifier or sound bar connected through HDMI<sup>®</sup>, and to display the external device's volume and mute status in the TV's on-screen display.

The TV automatically turns off its internal speakers and sends volume and mute control signals to an external amplifier when all of the following are true:

- ☒ **System audio control** is enabled on the TV.
- ☒ The TV is connected to a CEC-compatible amplifier, it is powered on, and CEC discoverability is enabled.
- ☒ The CEC-compatible amplifier's HDMI<sup>®</sup> ARC connector is connected to the TV's **HDMI ARC** connector with a suitable HDMI<sup>®</sup> cable.

When the CEC-compatible amplifier is off, the TV automatically turns on its speakers (unless you have turned them off as described in [Turning off the speakers](#)) and resumes local control of volume and mute state.

To enable or disable system audio control, in the Home screen menu, navigate to **Settings > System > Control other devices (CEC)** and highlight **System audio control**. Press **OK** to enable or disable the feature.

## Enable 1-touch play

1-touch play enables a device to control which TV input is active. For example, pressing **Play** on your Blu-ray™ player switches the TV to the Blu-ray™ input.

1-touch play is disabled by default. To enable 1-touch play, in the Home screen menu, navigate to **Settings > System > Control other devices (CEC)** and highlight **1-touch play**. Press **OK** to enable or disable the feature.

## Enable system standby

The system standby feature causes other devices to power off when you power off your TV. Depending on the CEC System Standby implementation, it might also enable connected devices to power off your TV when you power off the device.

System standby is disabled by default. To enable system standby, in the Home screen menu, navigate to **Settings > System > Control other devices (CEC)** and highlight **System standby**. Press **OK** to enable or disable the feature.

## Restarting the TV

You can restart the TV when necessary. Restarting has the same effect as unplugging the TV power and then plugging it in again.

To restart the TV, navigate to **Settings > System > Power**, and then select **System restart**. Highlight **Restart**, and then press **OK** to confirm restart.

While the TV restarts, the screen goes dark for a few seconds, and then displays the startup screen for a few more seconds. When the restart operation completes, the TV displays the activity you selected in [Power on settings](#).

## Resetting the TV

You can choose to reset only the TV picture and audio settings to their original values, or perform a full factory reset to return the TV to the state it was in when you first unpacked and turned it on.

### Reset audio/video settings

To reset only the TV picture and audio settings to their original values, navigate to **Settings > System > Advanced system settings > Factory reset**, and then highlight **Reset TV audio/video settings**. Read the information on the screen to make sure you understand what the reset operation does.

To proceed with the reset operation, press **PLAY/PAUSE** three times in a row.

## Factory reset everything

A full factory reset returns the TV's settings to their original state and removes all personally identifiable information from the TV. When finished, you must repeat Guided Setup, reconnecting to the Internet, re-linking your Roku account, and reloading any streaming channels. You also must repeat Antenna TV setup and input configuration.

Factory reset is the recommended choice if you want to transfer the TV to another owner, and it is the only choice if you want to switch from Store mode to Home mode (if you inadvertently selected Store mode during Guided Setup).

To perform a factory reset, navigate to **Settings > System > Advanced system settings > Factory reset**, and then highlight **Factory reset everything**. Read the information on the screen to make sure you understand what this reset operation does.

To proceed with the full factory reset, use the on-screen number pad to enter the code displayed on the screen, and then select **OK** to proceed.

When the factory reset operation completes, the TV restarts and displays the first Guided Setup screen.

## What if I can't access the Factory Reset option?

It is possible for your TV to get into a state where you cannot access the various menus, including the menu option that lets you perform a factory reset operation. If that happens, you can force the TV to reset by following these steps.

### Models with a RESET button

1. Using a straightened paper clip or ball-point pen, press and hold the recessed RESET button on the TV connector panel.
2. Continue to hold the RESET button for approximately 12 seconds.  
When the reset cycle completes, the status indicator comes on dim.
3. Release the RESET button. The TV is now powered off.
4. Turn on the TV and proceed through Guided Setup. See [Guided Setup](#).

## Models without a RESET button

1. On the TV panel (not the remote) press and hold down the MUTE and POWER buttons.
2. Unplug the TV power, and then plug it in while continuing to hold down the MUTE and POWER buttons.
3. When you see the startup screen appear on the TV, release the buttons.
4. Turn on the TV and proceed through Guided Setup. See [Guided Setup](#).

## Network connection reset

If you want to remove your network connection information without disturbing other settings, navigate from the Home screen to **Settings > System > Advanced systems settings > Network connection reset**, and then select **Reset connection**.

When you select this option, the TV removes your wireless network information, including the name of the connection (its SSID) and your wireless password, if any, and then it restarts. After restarting, your TV retains all of its other settings and its association with your Roku account.

After resetting your network connection, navigate from the Home screen to **Settings > Network > Set up new connection** to continue enjoying all of the benefits of your connected TV.

## Changing your Roku Channel Store PIN preference

When you created your Roku account, you were given the opportunity to create a PIN code and to specify when it must be used. If you created a Channel Store PIN and want to change it, or you don't remember your PIN, or if you didn't create a Channel Store PIN and want to add one, you can easily make these changes.

1. On a computer, tablet, or smartphone, use your web browser to go to <https://my.roku.com> and sign in.  
After signing in, the **My Account** page appears.
2. Under **PIN Preference**, click **Update** to open the **Choose Your PIN Preferences** page.

3. Skip this step if you just want to change your PIN. Otherwise, choose the option you prefer from among those listed:
  - Require a PIN to make purchases or to add any item from the Channel Store.
  - Require a PIN to make purchases.
  - Do not require a PIN to make purchases.
4. If you choose either of the first two options, enter your PIN twice in the appropriate boxes.
5. Click **Save Changes** to save your changes and return to the **My Account** page. Note that your current setting is described under **PIN Preference**.

## Getting system updates

If your TV is operating in connected mode, it will automatically get updates from time to time. You don't need to do anything. But if you are aware that an update is available and you don't want to wait until the TV updates itself, you can manually check for updates.

If your TV is operating in non-connected mode, you can still get updates by using a USB flash drive.

You can download an updated User Guide that matches your Roku TV software version from the Roku web site at:

[www.roku.com/support](http://www.roku.com/support)

To determine your current Roku TV software version, go to **Settings > System > About**, and then press **OK** or navigate to the right.

## Checking for updates on a connected TV

If you're one of those people who has to have the latest, most up-to-date features the moment they are available, you can check for updates as often as you want.

To check for updates, navigate to **Settings > System > System update**, and then select **Check now**. The TV responds either with a message saying that your TV is up to date, or with a message saying that an update is available.

Follow the instructions on the screen to install the system update.

**Note:** *Sometimes system updates install new system software, and other times they install new features for streaming channels. Therefore, you won't always see a change in the behavior of your TV after a system update.*

## Getting updates on a non-connected TV

If your TV is not connected to the Internet, you can still get system updates by using a USB flash drive and a computer with an Internet connection.

To get a system update, navigate to **Settings > System > System update:**

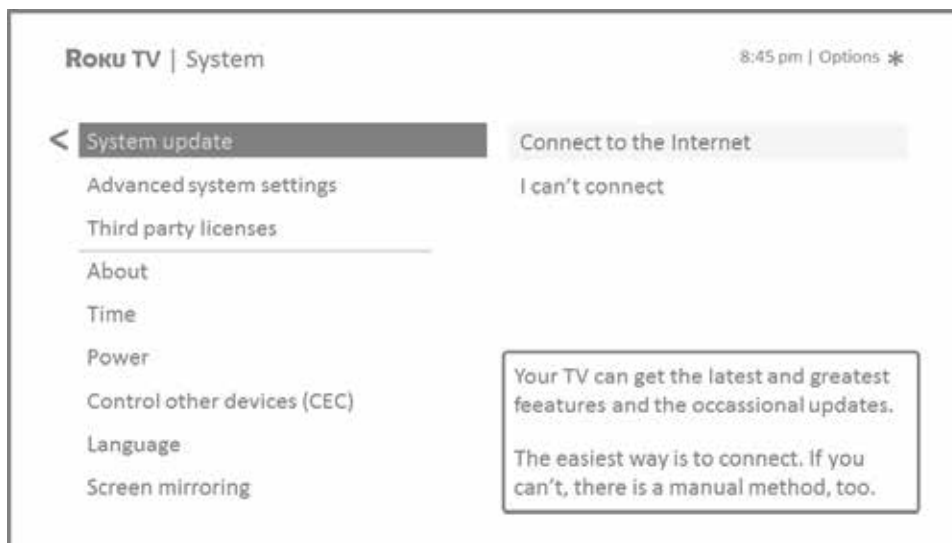

The **System update** screen on a non-connected TV gives you the opportunity to connect your TV to the Internet to automatically receive updates. We recommend this option if it is possible in your situation. To proceed, select **Connect to the Internet** and follow the instructions in [What if I didn't connect my TV?](#)

Otherwise, if you can't connect to the Internet, select **I can't connect**, and then follow the instructions on the screen. Here's a summary:

1. On an Internet -connected computer, go to the web site displayed on the **System update** screen.
2. On the **USB Update** web page, select the correct brand and model, and then click **Next**.
3. Click **Download Software**, and then save the file to the root folder of a standard USB flash drive.

---

### USB flash drive

Any normal USB flash drive will work, provided it has a FAT -16 or FAT -32 file system format. (This is the default for most flash drives.)

The size of the download is small —usually less than 100 MB —and so will fit on most any size flash drive you might have.

- 
4. When the download finishes, take the USB flash drive to the TV and plug it into the USB port. When you do, the TV validates the files on the flash drive and displays a 12-digit code.
  5. Write down the code and the web address, and take this information back to your Internet -connected computer.
  6. On the **12-digit code** page, enter the code your TV displayed, and then click **Next**.
  7. On the **6-digit code** page, write down the 6-digit code that appears, and then take it back to your TV.



---

## 12- and 6-digit codes

The USB update process uses a pair of codes to validate that you are authorized to install an update, and to ensure you are not attempting to install an old, unsupported version of the system software.

---

8. Using the TV remote, select **Next** to move to the next screen, and then use the on-screen keyboard to enter the 6-digit code . When finished, select **OK**. The system update begins. Do not remove the USB flash drive until the TV restarts.

When the update finishes, the TV restarts. You can check the new version number by navigating to **Settings > System > About**.

# Other devices

## Screen Mirroring your phone or tablet

*Only in connected mode*, your TV has a feature called screen mirroring that lets you mirror your compatible smartphone or tablet on your TV. Share videos, photos, web pages, and more from compatible devices.

By default, your TV's screen mirroring mode is set to **Prompt**. In this mode, when your TV receives a screen mirroring request, it prompts you with the following options, unless you have previously selected **Always accept** or **Always ignore** for the device:

- ☒ **Always accept** – Always accept mirrored content from the mobile device without additional prompting in the future for this device.
- ☒ **Accept** – Accept mirrored content from the mobile device this time only. Prompt again next time this device attempts to mirror content.
- ☒ **Ignore** – Do not accept mirrored content from the mobile device at this time. Prompt again next time this device attempts to mirror content.
- ☒ **Always ignore** – Never accept mirrored content from this mobile device.

**Note:** You can manage and change the list of devices that are set to **Always accept** or **Always ignore** by navigating from the Home screen to **Settings > System > Screen mirroring > Screen mirroring devices**.

- ☒ If you prefer to always allow all screen mirroring attempts without prompting, go to **Settings > System > Screen mirroring**, and then change the **Screen mirroring mode** to **Always allow**.
- ☒ If you prefer to never allow screen mirroring from any device, change the **Screen mirroring mode** to **Never allow**.

For information on which devices may work with screen mirroring and instructions on how to use it, go to the following link on the Roku web site:

[go.roku.com/screenmirroring](https://go.roku.com/screenmirroring)

## Getting and using the Roku mobile app

Roku makes the Roku mobile app free for compatible iOS<sup>®</sup> and Android™ mobile devices.

The Roku mobile app is an alternative remote for your Roku TV. The Roku mobile app helps you find and add new Roku Channels, more easily search and find something to watch and, *only in the United States*, even use your voice to search without typing.

Find more information and get the Roku mobile app by using the following link to the Roku web site:

[go.roku.com/mobileapp](https://go.roku.com/mobileapp)

## Private Listening on the Roku mobile app

*Only on compatible Apple and Android devices*, the Roku mobile app enables you to use headphones connected to your device to listen to streaming programs on Antenna TV channels. Make sure you have the latest version of the Roku mobile app before using this feature.

For more information, go to the following link on the Roku web site:

[go.roku.com/privatelistening](https://go.roku.com/privatelistening)

## Using a universal remote

In many cases, you can program your cable or satellite universal remote to also control your TV. You will need to have instructions for programming the remote handy. Check with your cable or satellite provider for instructions.

For details on how to set up the TV to work with universal remotes, go to the following link on the Roku web site:

[go.roku.com/universalremote](https://go.roku.com/universalremote)

# FAQ

For the latest answers to Frequently Asked Questions, visit the

Roku support website :

[go.roku.com/support](https://go.roku.com/support)

# Other information

## Notice

### Legal statement

Please note —Use of the Roku TV is governed by the Roku TV End User Agreement (see below). In addition, an end user online profile and billing account with Roku, Inc. (“Roku”) on Roku’s website (“Roku Account”) is required to stream content via the Internet using your Roku TV. A Roku Account gives you access to movies, television shows, and other audio-visual entertainment in the “Roku Channel Store,” a storefront of applications provided by Roku via your device’s on-screen menu. After your Roku Account is created, you can link your Roku TV to your account. By using the Roku TV, you agree to the following disclaimer. For the avoidance of doubt, the content disclaimer set forth herein shall refer to all content and channels accessible and available on the Roku TV, including those available via the Roku streaming platform, as well as broadcast cable.

Due to the various capabilities of the Roku TV, as well as limitations in the available content available therein, certain features, applications, and services may not be available on all Roku TVs, or in all territories. Some features on the Roku TV may also require additional peripheral devices or membership fees that are sold separately. Please visit the Roku, Inc. website for more information on the Roku TV and content availability. The services and availability of content on the Roku TV are subject to change from time to time without prior notice.

All content and services accessible through the Roku TV belong to third parties and are protected by copyright, patent, trademark and/or other intellectual property laws. Such content and services are provided solely for your personal noncommercial use. You may not use any content or services in a manner that has not been authorized by the content owner or service provider. Without limiting the foregoing, you may not modify, copy, republish, upload, post, transmit, translate, sell, create derivative works, exploit, or distribute in any manner or medium any content or services displayed through the Roku TV.

You expressly acknowledge and agree that your use of the Roku TV is at your sole risk and that the entire risk as to satisfactory quality, performance and accuracy is with you. The Roku TV and all third party content and services are provided “as is” without warranty of any kind, either express or implied. Roku expressly disclaims all warranties and conditions with respect to the Roku TV content and services, either express or implied, including but not limited to, warranties of merchantability, of satisfactory quality, fitness for a particular purpose, of accuracy, of quiet enjoyment, and non-infringement of third party rights. Roku does not guarantee the accuracy, validity, timeliness, legality, or completeness of any content or service made available through the Roku TV and does not warrant that the Roku TV will be uninterrupted or error-free. Under no circumstances, including negligence, shall Roku be liable, whether in contract or tort, for any direct, indirect, incidental, special or consequential damages, attorney fees, expenses, or any other damages arising out of, or in connection with, any information contained in, or as a result of the use of the device, or any content or service accessed by you or any third party, even if advised of the possibility of such damages.

Third party services may be changed, suspended, removed, terminated or interrupted, or access may be disabled at any time, without notice, and Roku makes no representation or warranty that any content or service will remain available for any period of time. Content and services are transmitted by third parties by means of networks and transmission facilities over which Roku has no control. Without limiting the generality of this disclaimer, Roku expressly disclaims any responsibility or liability for any change, interruption, disabling, removal of or suspension of any content or service made available through the Roku TV. Roku, the content providers, or the service providers may impose limits on the use of or access to certain services or content, in any case and without notice or liability. Any questions or requests for service relating to the content or services made available on the Roku TV should be submitted to the respective cable content or service provider or as described in the Roku TV User Guide.

In the event of a conflict between the Roku TV End User Agreement and the terms set forth in this Legal Disclaimer, the Roku TV End User Agreement shall prevail and control in all circumstances.

### END USER LICENSE AGREEMENT (FOR ROKU TV)

**IMPORTANT: READ THIS AGREEMENT CAREFULLY BEFORE YOU USE A ROKU TV. ALSO REVIEW THE IMPORTANT PRODUCT INFORMATION THAT MAY HAVE BEEN PROVIDED WITH YOUR ROKU TV.**

### Overview

This End User License Agreement (“EULA”) between you and Roku, Inc. (“Roku”) governs the use of: (a) your television which uses the Roku platform to play digital content over the Internet (“Television”), and (b) any firmware and software that have been pre-installed on the Television and the firmware and software updates Roku provides to you for the Television (collectively, the “Software”). By linking the Television to your account on Roku’s website (“Roku Account”) or using the Television, you are agreeing to this EULA. If you are a resident of the European Economic Area, by agreeing to this EULA, you expressly agree to waive your right to withdraw.

If you do not agree to this EULA, you do not have the right to use the Television or the Software. If you are within the allowable time period for returns under the applicable return policy, you may return the Television to your seller for a refund, subject to the terms of such return policy. You should perform a factory reset before you return it to erase data that may be stored on the Television. For instructions on how to reset your Television, please visit [www.roku.com/support](http://www.roku.com/support).

In this EULA, “Channel” means an application in the Roku Channel Store; “Content” means movies, television shows, music and other audio and visual materials and entertainment; “Content Provider” means any provider of Content; and “Roku Channel Store” means the storefront of applications provided by Roku via the Television’s on-screen menu.

## Changes to This EULA

Roku may amend this EULA at any time in its discretion. Such amendments shall be effective immediately upon posting of the amended EULA on Roku's website or via the Television or your Roku Account, whichever occurs first. If you have a Roku Account that is linked to your Television, then in its option, Roku may also notify you of the amended EULA by sending a notice to the last email address you have provided to Roku. You agree to provide accurate and complete information if and when you set up your Roku Account, and you agree to promptly update your account information (including contact information) to keep it accurate and complete. You can do this at any time by signing in to your Roku Account. Following such posting or notice by any of the methods described above, continued use of your Television or Roku Account means you accept and agree to the amended EULA. If you do not agree to the amended EULA, Roku may not be able to provide updates, upgrades or enhancements to your Television, and you may not be able to continue using your Television or Roku Account.

## Permitted Use and Restrictions

The Television and the Software are for personal, non-commercial use only. Copying or redistribution of any Content delivered via the Television is strictly prohibited and we may prevent or restrict you from copying or re-distributing any elements of the Software or Content using digital rights management or other technologies. The Television and the Software are for use only in those countries where the manufacturer of your Television has authorized its sale. If you are using the Television and the Software outside of these countries, the rights granted under this EULA do not apply. Some of the Content Providers use technologies to verify your geographic location, and you may not be able to use the Television or the Software to access any Content outside of the country or location authorized by Roku or the Content Provider. Except as expressly provided under this EULA, you do not acquire any intellectual property or other proprietary rights in or to the Television, the Software or the Content, including any rights in patents, inventions, improvements, designs, trademarks, database rights or copyrights, nor do you acquire any rights in any confidential information or trade secrets. All rights not expressly granted to you in this EULA are reserved by Roku or its applicable licensors. You may not remove, obscure, alter or conceal any trademark, logo, copyright or other proprietary notice in or on any Television, Software or Content.

The Software is proprietary to Roku or its third party licensors and may be used only with the Television. Subject to this EULA and, where appropriate, the applicable third party licenses, you have a non-exclusive, non-transferable license to run the Software and any updated versions provided to you by Roku, only in and as incorporated in the Television. This is a license and not a sale. You may not (a) copy, assign, sublicense, lease, sell or rent the Software; (b) distribute or otherwise transfer the Software except as incorporated in the Television, provided that you do not retain any copies of the Software and the recipient reads and agrees to this EULA (including all amendments); (c) modify, adapt, translate, or create derivative works of the Software (except only to the extent any of the foregoing restriction is prohibited by applicable law or as may be permitted by the license terms governing any Separately Licensed Code included with the Software); (d) decompile, disassemble, reverse engineer or otherwise derive source code from the Software, except to the extent such actions cannot be prohibited under applicable law because they are essential to achieve interoperability of the Software with another software program, and provided that the information obtained by you during such activities is (i) used only to achieve such interoperability; (ii) not disclosed without Roku's prior written consent; and (iii) not used to create any software that is substantially similar to the Software; (e) defeat, bypass, circumvent or interfere with any security mechanism or access control measures, or (f) have any of the foregoing done for you by a third party. This license does not include the right to receive Software upgrades or updates. Your right to use the Television and the Software will immediately terminate upon your breach of this EULA.

## Software Updates

IN ITS SOLE DISCRETION, ROKU MAY PROVIDE UPDATES TO YOUR TELEVISION VIA THE INTERNET, INCLUDING BUG FIXES AND UPDATES, CHANGES IN THE USER INTERFACE OR HOW YOU ACCESS CONTENT, AND OTHER CHANGES THAT MAY ADD, ALTER OR REMOVE FUNCTIONALITIES AND FEATURES. YOU ACKNOWLEDGE THAT THESE UPDATES: (A) MAY HAPPEN AUTOMATICALLY IN THE BACKGROUND AT ANY TIME (AND THAT THEY CANNOT BE DISABLED BY YOU); AND (B) WILL REQUIRE AN INTERNET CONNECTION AND YOU MAY INCUR ADDITIONAL DATA CHARGES FROM THE PROVIDER OF THE INTERNET CONNECTION. YOU UNDERSTAND THAT THESE UPDATES ARE NECESSARY TO MAINTAIN COMPATIBILITY WITH OTHER UPDATES TO ROKU'S PRODUCTS OR SERVICES AND MAY BE REQUIRED FOR SECURITY REASONS. BY USING THE TELEVISION, YOU HEREBY AGREE TO RECEIVE SUCH UPDATES.

## Separately Licensed Code

Certain software components of the Software are provided under separate third party license terms ("Separately Licensed Code") and your right to use such components is governed by such license terms. Please visit [go.roku.com/seperatelylicensedcode](http://go.roku.com/seperatelylicensedcode) for more information.

## Voice Search

If downloaded to your phone or mobile device, the Roku mobile app allows you to use your voice to search for content on your Television using voice search. When you choose to use voice search, you agree that Roku and/or a third party vendor contracted by Roku have your consent to record, process and store your voice inputs (e.g., a recording and the interpretation of what was said), and use such voice inputs with other information about your Television (e.g., device identifier) to provide services related to voice search to you, to improve the accuracy and quality of the service, and as described in Roku's Privacy Policy. To learn more about voice search, visit the FAQ pages of Roku's website at [www.roku.com/support](http://www.roku.com/support).

## NO WARRANTY FROM ROKU; Limitation of LIABILITY

YOUR warranty with respect to the Television is provided by THE TELEVISION'S MANUFACTURER, and not by Roku. ROKU OFFERS NO WARRANTY TO YOU UNDER THIS EULA. WITHOUT LIMITING THE GENERALITY OF THE FOREGOING DISCLAIMER, TO THE MAXIMUM EXTENT PERMITTED BY APPLICABLE LAW :

- (A) THE SEPARATELY LICENSED CODE AND THE SOFTWARE ARE PROVIDED "AS IS", WITH ALL FAULTS AND WITHOUT WARRANTY OF ANY KIND . ROKU DISCLAIMS ALL OTHER WARRANTIES AND CONDITIONS , INCLUDING THE IMPLIED WARRANTY OF MERCHANT ABILITY, SATISFACTORY QUALITY, FITNESS FOR A PARTICULAR PURPOSE AND NON -INFRINGEMENT. ROKU DOES NOT GUARANTEE, REPRESENT, OR WARRANT THAT THE TELEVISION, THE SEPARATELY LICENSED CODE AND THE SOFTWARE WILL BE: (I) SECURE, VIRUS -FREE OR ERROR -FREE, OR ( II) F REE FROM ATTACK OR SECURITY INTRUSION.
- (B) IN NO EVENT SHALL ROKU, ITS DIRECTORS, OFFICERS OR EMPLOYEES BE LIABLE TO YOU FOR PERSONAL INJURY OR PROPERTY DAMAGE , OR ANY SPECIAL, INCIDENTAL, EXEMPLARY, PUNITIVE, INDIRECT OR CONSEQUENTIAL DAMAGES OF ANY KIND ARISING OUT OF ANY TELEVISION , THE SEPARATELY LICENSED CODE, THE SOFTWARE, OR YOUR USE THEREOF ; AND
- (C) YOU AGREE THAT (I) THE TOTAL CUMULATIVE LIABILITY OF ROKU, ITS DIRECTORS, OFFICERS AND EMPLOYEES UNDER THIS EULA , INCLUDING LIABILITY RELATING TO ALL TELEVISIONS LINKED TO YOUR ROKU ACCOUNT, AND THE SEPARATELY LICENSED CODE AND THE SOFTWARE IN SUCH TELEVISIONS, AND YOUR USE THEREOF , SHALL NOT EXCEED THE AMOUNT SET FORTH IN THE ROKU ACCOUNT TERMS AND CONDITIONS YOU AGREED TO FOR YOUR ROKU ACCOUNT, AND (I I) ROKU, ITS DIRECTORS, OFFICERS AND EMPLOYEES SHALL NOT BE LIABLE TO YOU UNDER THIS EULA FOR ANY DIRECT DAMAGES ARISING OUT OF, OR IN CONNECTION WITH THE TELEVISION. THE FOREGOING LIMITATIONS SHALL APPLY EVEN IF THE REMEDY PROVIDED HEREIN FAILS ITS ESSENTIAL PURPOSE AND EVEN IF ROKU, ITS DIRECTORS, OFFICERS OR EMPLOYEES HAVE BEEN ADVISED OF THE POSSIBILITY OF SUCH LIABILITY .

SOME JURISDICTIONS DO NOT ALLOW EXCLUSIONS OF CERTAIN WARRANTIES OR LIMITATIONS OF LIABILITY FOR CERTAIN TYPES OF DAMAGES, SO SOME OF THE ABOVE LIMITATIONS IN THIS SECTION MAY NOT APPLY TO YOU. NOTHING IN THESE TERMS OF USE SHALL AFFECT ANY NON -WAIVABLE STATUTORY RIGHTS THAT APPLY TO YOU, AND YOU MAY ALSO HAVE OTHER RIGHTS THAT VARY FROM JURISDICTION TO JURISDICTION.

## Export Controls

You agree not to download any Content or Software, nor otherwise export or re-export any Television or the Software into (or to a national or resident of) Cuba, Iraq, Libya, North Korea, Iran, Syria or any other country as to which the United States or your country has embargoed goods, or to anyone on the U.S. Treasury Department's List of Specially Designated Nationals or the U.S. Commerce Department's Table of Denial Orders or on similar restricted lists published by your government from time to time. By using any Television or the Software , you are representing and warranting that you are not located in, under the control of, or a national or resident of any such country or on any such list.

## Choice of Law; Dispute Resolution

- A. If you are a consumer and a resident in any country in the European Economic Area where the sale of the Television is expressly authorized by its manufacturer, this EULA does not apply to you.
- B. In all other cases, including if you are a resident of the United States (and its possessions and territories) or Canada, you agree that this EULA shall be governed by the laws of the State of California without regard to any conflict of laws principles that may provide the application of the law of another jurisdiction; and:
1. You and Roku agree to be bound by the procedures set forth below to resolve any and all claims between you and Roku arising out of or relating to any aspect of this EULA , whether based in contract, tort, statute, fraud, misrepresentation or any other legal theory, including but not limited to, claims between you and Roku related to the Television and the Software . Each such claim is referred to individually as "Claim" and collectively as "Claims".
  2. **You and Roku agree that, except for THE claims identified in paragraph 4 of this section below, any and all CLAIMS BETWEEN YOU AND ROKU shall be finally settled by binding arbitration.** The arbitration shall take place in Santa Clara County, California and shall be administered by the American Arbitration Association ("AAA") pursuant to the AAA's then-current rules, including (if applicable) the AAA's Supplementary Procedures for Consumer-Related Disputes. Please be aware there is no judge or jury in arbitration. Arbitration procedures are simpler and more limited than the rules applicable in court, and review of the arbitrator's decision by a court is limited. **YOU AND ROKU FURTHER AGREE THAT EACH OF YOU MAY BRING CLAIMS AGAINST THE OTHER ONLY ON AN INDIVIDUAL BASIS AND NOT AS A PLAINTIFF OR CLASS MEMBER IN ANY PURPORTED CLASS OR REPRESENTATIVE ACTION OR PROCEEDING.** The arbitrator may not consolidate or join more than one person's claim and may not preside over any consolidated, representative or class proceeding. Also, the arbitrator may award relief (including monetary, injunctive or declaratory relief) only on an individual basis and may not award any form of consolidated, representative or class-wide relief. Notwithstanding any provision in these terms to the contrary, if the class-action waiver in this provision is deemed invalid or unenforceable, or if an arbitration is allowed to proceed on a class basis, then neither you nor Roku are entitled to arbitrate the Claims . This arbitration provision is subject to the Federal Arbitration Act. The

- arbitrator's award shall be binding on you and Roku, and may be entered in any court of competent jurisdiction.
- Information on AAA and how arbitration is initiated can be found at [www.adr.org](http://www.adr.org) or by calling 800-778-7879. For Claims between You and Roku of \$75,000 or less, you will be responsible for the initial arbitration filing fee, up to the amount of the initial filing fee if you were to initiate a lawsuit against Roku based on such Claims in court. If the arbitrator finds such Claims to be non-frivolous, Roku will pay any difference in such filing fees plus the arbitrator fees. For Claims between You and Roku in excess of \$75,000, if you are able to demonstrate that the costs of arbitration will be prohibitive as compared to the costs of litigation, Roku will pay as much of your actual filing fees and the arbitrator fees for the arbitration as the arbitrator deems necessary to prevent the arbitration from being cost-prohibitive as compared to the cost of litigation.
  - This agreement to arbitrate does not apply to any Claim (a) in which a party is attempting to protect its intellectual property rights (such as its patent, copyright, trademark, trade secret, or moral rights, but not including its privacy or publicity rights), or (b) that may be brought in small-claims court.
  - If the agreement to arbitrate in this provision is found to be invalid, unenforceable or inapplicable to a given Claim between You and Roku, then any and all proceedings to resolve such Claim must be brought exclusively in a federal court of competent jurisdiction in the Northern District of California or in a state court in Santa Clara County, California. You hereby irrevocably consent to the exclusive jurisdiction and venue of such courts.
  - 30-Day Right to Opt Out:** You have the right to opt out of this agreement to arbitrate by sending a written notice of your decision to opt out to the following address: Legal Department, Roku, Inc., 150 Winchester Circle, Los Gatos, CA 95032, USA; provided that, such notice must be postmarked on or before the 30th day after the first to occur of the following events if you do not already have a Roku Account: (a) the date of purchase of Your Television, or (b) the date you create your Roku Account. If you have an existing Roku Account, all devices you choose to link to your Roku Account, and all services provided by Roku which are accessed using these devices, will be subject to this agreement to arbitrate. Your notice should include your full name, your current postal address, telephone number and email address, the product name and serial number for Your Television, and a copy of the original proof of purchase for your Television. If you timely send a notice in compliance with this paragraph 6, the agreement to arbitrate will not apply to either you or Roku. If you do not timely send this notice, then you agree to be bound by this agreement to arbitrate.
  - Notwithstanding any provision in this Agreement to the contrary, you agree that, if Roku seeks to delete or materially modify the agreement to arbitrate described herein, any such deletion or modification will not apply to any individual Claim of which you have notified Roku prior to such modification.

## Miscellaneous

Roku may transfer its rights and obligations under this EULA to another organization. You may only transfer your rights or your obligations under this EULA to another person if Roku agrees in writing. This EULA is between you and Roku. No other person shall have any rights to enforce these terms. Each of the paragraphs of this EULA operates separately. If any court or relevant authority decides that any of them are unlawful, the remaining paragraphs will remain in full force and effect. If Roku fails to insist that you perform any of your obligations under this EULA, or if Roku does not enforce its rights against you, or if Roku delays in doing so, that will not mean that Roku has waived its rights against you, or that you do not have to comply with those obligations. If Roku does waive a default by you, Roku will only do so in writing, but that will not mean that Roku will automatically waive any later default by you.

## Contact Information

If you wish to contact Roku, please send your correspondence by mail to Roku, Inc., 150 Winchester Circle, Los Gatos, CA 95032 USA, or by email to [customerservice@roku.com](mailto:customerservice@roku.com).

Last Updated: April 21, 2016



## CONTRAT DE LICENCE D'UTILISATEUR FINAL (POUR ROKU TV)

**IMPORTANT : LIRE ATTENTIVEMENT CE CONTRAT AVANT D'UTILISER UN TÉLÉVISEUR ROKU TV. PASSER ÉGALEMENT EN REVUE LES RENSEIGNEMENTS IMPORTANTS RELATIFS AU PRODUIT QUI PEUVENT AVOIR ÉTÉ FOURNIS AVEC VOTRE TÉLÉVISEUR ROKU TV.**

### Aperçu

Le présent contrat de licence d'utilisateur final (« **CLUF** ») conclu entre vous et Roku, Inc. (« **Roku** ») régit l'utilisation de : (a) votre téléviseur qui se sert de la plateforme Roku pour lire du contenu numérique sur Internet (« **Téléviseur** ») et (b) tous les microprogrammes et logiciels qui ont été préinstallés sur le Téléviseur, ainsi que les mises à jour des microprogrammes et logiciels que Roku met à votre disposition pour le Téléviseur (collectivement le « **Logiciel** »). Lier le Téléviseur à votre compte sur le site Web de Roku (« **Compte Roku** ») ou utiliser le Téléviseur signifie que vous acceptez ce CLUF. Si vous résidez sur le territoire économique européen et acceptez ce CLUF, vous acceptez expressément de renoncer à votre droit de rétractation.

Si vous n'acceptez pas le présent CLUF, vous ne pouvez pas utiliser le Téléviseur ni le Logiciel. Si le délai autorisé pour les retours n'est toujours pas échu en vertu de la politique de retour applicable, vous pouvez retourner le Téléviseur à votre vendeur pour obtenir un remboursement, sous réserve des modalités d'une telle politique de retour. Vous devez effectuer une réinitialisation d'usine avant de retourner l'appareil afin d'effacer les données pouvant être stockées sur le Téléviseur. Pour obtenir des renseignements sur la façon de réinitialiser votre Téléviseur, veuillez visiter la page [www.roku.com/support](http://www.roku.com/support).

Dans le présent CLUF, « **Canal** » désigne une application de la boutique de canaux Roku; « **Contenu** » désigne des films, des séries télévisées, de la musique et tout autre contenu et divertissement audiovisuel; « **Fournisseur de contenu** » désigne tout fournisseur de Contenu et « **Boutique de canaux Roku** » désigne la vitrine d'applications fournies par Roku par l'intermédiaire du menu à l'écran du Téléviseur.

### Modifications au présent CLUF

Roku peut modifier ce CLUF à tout moment à sa discrétion. Ces modifications entreront en vigueur immédiatement après la publication du CLUF modifié sur le site Web de Roku, le Téléviseur ou votre compte Roku, selon la première éventualité. Si vous disposez d'un compte Roku associé à votre Téléviseur, Roku peut également, à sa discrétion, vous informer du CLUF modifié en envoyant un avis à la dernière adresse électronique que vous avez indiqué à Roku. Vous acceptez de fournir des renseignements exacts et complets lorsque vous configurez votre compte Roku et vous vous engagez à mettre rapidement à jour les renseignements de votre compte, y compris vos coordonnées, afin qu'ils soient exacts et complets. Vous pouvez le faire à tout moment en vous connectant à votre compte Roku. À la suite d'une telle annonce ou d'un tel avis par l'une des méthodes décrites ci-dessus, continuer à utiliser votre Téléviseur ou votre compte Roku signifie que vous acceptez le CLUF modifié. Si vous n'acceptez pas le CLUF modifié, Roku ne sera pas en mesure de fournir des mises à jour, des mises à niveau ou des améliorations pour votre Téléviseur, et vous pourriez ne plus être en mesure de continuer à utiliser votre Téléviseur ou votre compte Roku.

### Utilisation autorisée et restrictions

Le Téléviseur et le Logiciel sont destinés à un usage personnel et non commercial uniquement. Toute reproduction ou toute redistribution du contenu offert par le Téléviseur est strictement interdite et nous pourrions vous empêcher de copier ou de redistribuer tout élément du Logiciel ou du contenu à l'aide d'un système de gestion des droits numériques ou d'autres technologies. Le Téléviseur et le Logiciel sont uniquement destinés à une utilisation dans les pays dans lesquels le fabricant de votre Téléviseur a autorisé leur vente. Si vous utilisez le Téléviseur et le Logiciel en dehors de ces pays, les droits accordés en vertu du présent CLUF ne s'appliquent pas. Certains des Fournisseurs de contenu utilisent des technologies qui permettent de vérifier votre situation géographique et vous pourriez ne pas être en mesure d'utiliser le Téléviseur ou le Logiciel pour accéder au Contenu en dehors du pays ou de l'emplacement autorisé par Roku ou le Fournisseur de contenu. Sauf dans la mesure expressément indiquée dans le présent CLUF, vous n'acquerez aucune propriété intellectuelle ou aucun autre droit de propriété de quelque nature sur le Téléviseur, le Logiciel ou le Contenu, y compris les droits de brevets, les inventions, les améliorations, les conceptions, les marques, les droits de base de données ou les droits d'auteur, et vous n'acquerez aucun droit sur tout renseignement confidentiel ou secret commercial. Tous les droits qui vous ne sont pas expressément concédés dans le présent CLUF sont réservés par Roku ou ses concédants de licence applicables. Vous ne pouvez pas supprimer, obscurcir, modifier ou dissimuler toute marque, tout logo, tout droit d'auteur ou toute autre mention de droit de propriété dans ou sur n'importe quel Téléviseur, Logiciel ou Contenu.

Le Logiciel est la propriété de Roku ou d'une tierce partie licenciée et peut être utilisé uniquement avec le Téléviseur. Sous réserve du présent CLUF et, le cas échéant, des licences applicables de tiers, vous détenez une licence non exclusive et non transférable d'utilisation du Logiciel et de toute version mise à jour qui vous est fournie par Roku, seulement dans le Téléviseur et sous la forme qu'il incorpore. Ceci constitue une licence et non une vente. Vous ne pouvez pas (a) copier, céder, louer ou vendre le Logiciel ou accorder une sous-licence pour ce dernier; (b) distribuer ou autrement transférer le Logiciel, sauf comme incorporé dans le Téléviseur, pourvu que vous ne conserviez aucune copie du Logiciel et que le destinataire lit et s'engage à respecter cet accord de licence (y compris tous les amendements); (c) modifier, adapter, traduire ou créer des œuvres dérivées du Logiciel (sauf dans la mesure où toute restriction qui précède est interdite par la loi applicable ou jugée

acceptable par les termes de la licence régissant tout code utilisé avec autorisation fourni avec le Logiciel); (d) décompiler, désassembler, désosser ou autrement extraire le code source du Logiciel, sauf dans la mesure où ces gestes ne peuvent être interdits en vertu de la loi applicable parce qu'ils sont essentiels à l'interopérabilité du Logiciel avec un autre logiciel, et pourvu que les renseignements obtenus par vous au cours de ces activités sont (i) utilisés uniquement pour réaliser cette interopérabilité; (ii) non divulgués sans le consentement écrit de Roku obtenu préalablement; et (iii) ne sont pas utilisés pour créer un logiciel qui est substantiellement similaire au Logiciel; (e) usurper, contourner ou gêner tout mécanisme de sécurité ou toute mesure de contrôle d'accès, ou (f) faire effectuer ce qui précède pour vous par un tiers. Cette licence n'inclut pas le droit de recevoir des mises à jour ou des mises à niveau logicielles. Votre droit d'utiliser le Téléviseur et le Logiciel sera immédiatement annulé sur violation du présent CLUF.

## Mises à jour logicielles

À SA SEULE DISCRÉTION, ROKU PEUT FOURNIR DES MISES À JOUR SUR VOTRE TÉLÉVISEUR PAR INTERNET, Y COMPRIS DES CORRECTIFS, DES MISES À JOUR, DES MODIFICATIONS DE L'INTERFACE OU DE LA MANIÈRE D'ACCÉDER AU CONTENU, ET D'AUTRES CHANGEMENTS QUI PEUVENT AJOUTER, ALTÉRER OU SUPPRIMER DES FONCTIONNALITÉS ET DES CARACTÉRISTIQUES. VOUS RECONNAÎSSEZ QUE CES MISES À JOUR (A) PEUVENT SE PRODUIRE AUTOMATIQUEMENT EN ARRIÈRE -PLAN À TOUT MOMENT (ET QU'ELLES NE PEUVENT PAS ÊTRE DÉSACTIVÉES PAR VOUS); ET (B) NÉCESSITENT UNE CONNEXION INTERNET ET QUE VOUS POURRIEZ DEVOIR PAYER DES FRAIS DE DONNÉES SUPPLÉMENTAIRES À VOTRE FOURNISSEUR DE CONNEXION INTERNET. VOUS COMPRENEZ QUE CES MISES À JOUR SONT NÉCESSAIRES POUR MAINTENIR LA COMPATIBILITÉ AVEC LES AUTRES MISES À JOUR DE PRODUITS OU DE SERVICES DE ROKU ET QU'ELLES PEUVENT ÊTRE NÉCESSAIRES POUR DES RAISONS DE SÉCURITÉ. EN UTILISANT LE TÉLÉVISEUR, VOUS ACCEPTEZ DE RECEVOIR CES MISES À JOUR.

## Code sous licence distincte

Certains composants du Logiciel sont fournis sous les termes distincts de licence de tiers (« Code sous licence distincte ») et votre droit d'utiliser ces composants est régi par les modalités de cette licence. Veuillez visiter le <https://www.roku.com/separatelylicensedcode> pour obtenir de plus amples renseignements.

## Recherche vocale

Si vous la téléchargez sur votre téléphone ou appareil mobile, l'application mobile Roku vous permet d'utiliser votre voix et la recherche vocale pour chercher du contenu sur votre Téléviseur. Lorsque vous choisissez d'utiliser la recherche vocale, vous acceptez que Roku et/ou un fournisseur tiers fournisseur engagé par Roku aient votre consentement pour enregistrer, traiter et stocker vos entrées vocales (par exemple, un enregistrement et l'interprétation de ce qui a été dit) et utilisent ces entrées vocales avec d'autres renseignements sur votre Téléviseur (par exemple, identificateur de périphérique) pour fournir des services liés à la recherche vocale pour vous afin d'améliorer la précision et la qualité du service, comme cela est décrit dans la politique de confidentialité de Roku. Pour en savoir plus sur la recherche vocale, visitez les pages de FAQ du site de Roku au [www.roku.com/support](http://www.roku.com/support).

## AUCUNE GARANTIE DE LA PART DE ROKU; LIMITATION DE RESPONSABILITÉ

VOTRE GARANTIE RELATIVE AU TÉLÉVISEUR EST FOURNIE PAR LE FABRICANT DU TÉLÉVISEUR ET NON PAS PAR ROKU. ROKU NE VOUS OFFRE AUCUNE GARANTIE EN VERTU DU PRÉSENT CLUF. SANS RESTREINDRE LA PORTÉE GÉNÉRALE DU PRÉSENT AVIS DE NON -RESPONSABILITÉ, DANS LES LIMITES PERMISES PAR LES LOIS APPLICABLES :

- (A) LE CODE SOUS LICENCE DISTINCTE ET LE LOGICIEL SONT FOURNIS « TELS QUELS », ERREURS COMPRISES, SANS GARANTIE D'AUCUNE SORTE. ROKU RENONCE À TOUTES LES AUTRES GARANTIES ET CONDITIONS, Y COMPRIS LA GARANTIE IMPLICITE DE QUALITÉ MARCHANDE, DE QUALITÉ SATISFAISANTE, D'ADÉQUATION À UN USAGE PARTICULIER ET D'ABSENCE DE CONTREFAÇON. ROKU NE PEUT GARANTIR, DÉCLARER NI CERTIFIER QUE LE TÉLÉVISEUR, LE CODE SOUS LICENCE DISTINCTE ET LE LOGICIEL SERONT : (I) SÉCURISÉS, SANS VIRUS OU SANS ERREUR, OU (II) DÉNUÉS DE TOUTE ATTAQUE OU INTRUSION DE SÉCURITÉ.
- (B) EN AUCUN CAS ROKU, SES ADMINISTRATEURS, SES DIRIGEANTS OU SES EMPLOYÉS NE SERONT RESPONSABLES ENVERS VOUS POUR TOUTE LÉSION CORPORELLE OU TOUT DOMMAGE MATÉRIEL, OU TOUT DOMMAGE PARTICULIER, ACCESSOIRE, EXEMPLAIRE, PUNITIF, INDIRECT OU IMMATÉRIEL DE QUELQUE NATURE DÉCOULANT DE TOUT TÉLÉVISEUR, CODE SOUS LICENCE DISTINCTE, LOGICIEL OU DE VOTRE UTILISATION DE CEUX -CI; ET
- (C) VOUS ACCEPTEZ QUE (I) LA RESPONSABILITÉ CUMULATIVE DE ROKU, DE SES ADMINISTRATEURS, SES DIRIGEANTS OU SES EMPLOYÉS, EN VERTU DU PRÉSENT CLUF, NOTAMMENT SA RESPONSABILITÉ CONCERNANT TOUS LES TÉLÉVISEURS ASSOCIÉS À VOTRE COMPTE ROKU, AINSI QUE LE CODE LICENCE DISTINCTE ET LE LOGICIEL INSTALLÉ SUR DE TELS TÉLÉVISEURS, ET VOTRE UTILISATION DE CEUX -CI, NE DÉPASSERA PAS LE MONTANT SPÉCIFIÉ DANS LES CONDITIONS GÉNÉRALES DU COMPTE ROKU QUE VOUS AVEZ ACCEPTÉES POUR VOTRE COMPTE ROKU, ET QUE (II) ROKU, SES ADMINISTRATEURS, SES DIRIGEANTS ET SES EMPLOYÉS NE SERONT PAS RESPONSABLES ENVERS VOUS, EN VERTU DU PRÉSENT CLUF, POUR LES DOMMAGES DIRECTS DÉCOULANT DU TÉLÉVISEUR OU EN LIEN AVEC CELUI -CI. LES LIMITATIONS CI -DESSUS S'APPLIQUENT MÊME SI LE RECOURS PRÉVU AUX PRÉSENTES ÉCHOUE DANS SON OBJECTIF PRINCIPAL ET MÊME SI ROKU, SES ADMINISTRATEURS, DIRIGEANTS OU SES EMPLOYÉS ONT ÉTÉ AVISÉS DE LA POSSIBILITÉ D'UNE TELLE RESPONSABILITÉ.

CERTAINS TERRITOIRES N'AUTORISENT PAS L'EXCLUSION DE CERTAINES GARANTIES OU LA LIMITATION DE RESPONSABILITÉ POUR CERTAINS TYPES DE DOMMAGES, CERTAINES LIMITATIONS MENTIONNÉES DANS CETTE SECTION PEUVENT NE PAS VOUS CONCERNER. RIEN DANS LES PRÉSENTES CONDITIONS D'UTILISATION NE DOIT AFFECTER TOUT DROIT ACCORDÉ PAR LA LOI QUI S'APPLIQUE À VOUS ET VOUS POURRIEZ AUSSI DISPOSER D'AUTRES DROITS QUI VARIENT D'UN TERRITOIRE À L'AUTRE.

## Contrôles à l'exportation

Vous acceptez de ne pas télécharger tout Contenu ou Logiciel, ni autrement exporter ou réexporter tout Téléviseur ou Logiciel dans (ou à un ressortissant ou un résident de) Cuba, Irak, Libye, Corée du Nord, Iran, Syrie ou tout autre pays contre lequel les États-Unis ou votre pays tient un embargo, ou à toute personne figurant sur la List of Specially Designated Nationals du Treasury Department des États-Unis ou du Table of Denial Orders du Commerce Department des États-Unis ou toute autre liste restreinte similaire publiée par votre gouvernement de temps à autre. En utilisant un Téléviseur ou le Logiciel, vous représentez un pays autre que ceux figurant sur une telle liste et vous garantissez que vous n'êtes pas situé dans un tel pays, sous le contrôle d'un tel pays, ou que vous n'êtes pas un ressortissant ou un résident d'un tel pays.

## Choix de compétence; règlement des litiges

- A. Si vous êtes un consommateur ou un résident d'un pays appartenant au territoire économique européen dans lequel la vente du Téléviseur est expressément autorisée par son fabricant, le présent CLUF ne s'applique pas à votre cas.
- B. Dans tous les autres cas, notamment si vous êtes un résident des États-Unis (et de ses possessions et territoires) ou du Canada, vous acceptez que cet accord de licence soit régi par les lois de l'état de la Californie, sans tenir compte de tout conflit de principes de droit qui peut s'appliquer à la loi d'un autre territoire; et :
  1. Vous et Roku acceptez d'être liés par les modalités énoncées ci-dessous pour résoudre toute réclamation entre vous et Roku résultant de tout aspect du présent CLUF ou relative à celle-ci, qu'elle se fonde sur un contrat, un délit civil, une loi, une fraude, une fausse déclaration ou toute autre théorie juridique, y compris, mais sans s'y limiter, à des réclamations entre vous et Roku liées au Téléviseur et au Logiciel. Chaque réclamation est dénommée individuellement en tant que « **Réclamation** » et collectivement en tant que « **Réclamations** ».
  2. VOUS ET ROKU CONSENTEZ À CE QUE TOUTE RÉCLAMATION ENTRE VOUS ET ROKU SOIT TRANCHÉE DE FAÇON DÉFINITIVE PAR ARBITRAGE, À L'EXCEPTION DES RÉCLAMATIONS QUI FIGURENT AU PARAGRAPHE 4 CI-APRÈS DE LA PRÉSENTE SECTION. L'arbitrage doit avoir lieu dans le comté de Santa Clara, en Californie, et doit être administré par l'American Arbitration Association (l'« AAA ») suivant les règles en vigueur de l'AAA, incluant (le cas échéant) les Procédures Additionnelles de l'AAA concernant les différends de consommateurs. Soyez informé qu'il n'y a aucun juge ni jury en arbitrage. Les procédures d'arbitrage sont simplifiées et plus limitées que les règles applicables devant les tribunaux et la révision des décisions de l'arbitre par un tribunal est limitée. VOUS ET ROKU CONSENTEZ EN OUTRE À CE QUE VOUS ET ROKU PUISSIEZ PRÉSENTER UNE RÉCLAMATION À L'ENCONTRE DE L'AUTRE PARTIE UNIQUEMENT SUR UNE BASE INDIVIDUELLE ET NON À TITRE DE REQUÉRANT OU DE MEMBRE D'UN GROUPE DANS TOUTE ACTION OU TOUT RECOURS COLLECTIF. L'ARBITRE NE PEUT CONSOLIDER OU JOINDRE PLUS D'UNE RÉCLAMATION PAR PERSONNE ET NE PEUT PRÉSIDER AUCUN RECOURS CONSOLIDÉ OU COLLECTIF. L'ARBITRE PEUT ACCORDER TOUTE FORME DE RÉPARATION (INCLUANT UNE RÉPARATION MONÉTAIRE, INJONCTION OU MESURE DÉCLARATOIRE) SUR UNE BASE INDIVIDUELLE SEULEMENT ET NE PEUT ACCORDER AUCUNE FORME DE RÉPARATION CONSOLIDÉE OU COLLECTIVE. Nonobstant toute disposition contraire, si la renonciation au recours collectif prévue au présent paragraphe est jugée invalide ou non exécutoire ou si un arbitrage est autorisé à procéder sur une base collective, ni vous ni Roku ne serez dès lors autorisés à soumettre les Réclamations à l'arbitrage. La présente clause d'arbitrage est assujettie au Federal Arbitration Act. La décision de l'arbitre liera vous et Roku et peut être homologuée par tout tribunal compétent.
  3. Vous trouverez les renseignements concernant l'AAA et la façon dont l'arbitrage est initié à l'adresse [www.adr.org](http://www.adr.org) ou en téléphonant au 800-778-7879. Pour toute Réclamation entre Vous et Roku de 75 000 USD et moins, vous serez responsable des frais initiaux de demande d'arbitrage, jusqu'à concurrence du montant des frais initiaux de la demande que vous auriez été appelé à payer pour une poursuite judiciaire initiée pour ces mêmes Réclamations à l'encontre de Roku devant les tribunaux. Si l'arbitre juge les Réclamations non frivoles, Roku paiera la différence entre de tels frais plus les frais de l'arbitrage. Pour toute Réclamation entre vous et Roku qui excède 75 000 USD, si vous êtes en mesure de démontrer que les frais de l'arbitrage sont prohibitifs par rapport aux frais de justice, Roku paiera le montant de vos frais de demande réels et les frais de l'arbitrage, jugés nécessaires par l'arbitre afin d'éviter que les frais d'arbitrage ne deviennent prohibitifs par rapport aux frais de justice.
  4. Cette convention d'arbitrage ne concerne pas toute revendication (a) dans laquelle une partie tente de protéger ses droits de propriété intellectuelle (tels que son brevet, copyright, marque déposée, secret commercial, ou des droits moraux, mais ne comprend pas sa vie privée ou les droits de publicité), ou (b) qui peut être intentée devant le tribunal des petites créances.
  5. Si cette entente d'arbitrage est jugée invalide, non exécutoire ou inapplicable pour une Réclamation donnée entre Vous et Roku, toute procédure visant à résoudre telle Réclamation devra dès lors être présentée exclusivement devant un tribunal fédéral ayant juridiction dans le District Nord de Californie

ou un tribunal d'État du comté de Santa Clara en Californie. Vous consentez irrévocablement à la juridiction exclusive de ces tribunaux.

- Droit de retrait de 30 jours :** vous avez le droit de vous retirer de cette entente d'arbitrage en envoyant un avis écrit de votre décision de vous retirer à l'adresse suivante : Legal Department, Roku, Inc., 150 Winchester Circle, Los Gatos, CA 95032, États-Unis; à condition que le cachet d'un tel avis soit daté du 30e jour, ou moins, suivant le premier événement se produisant parmi les choix ci-après, si vous ne possédez pas encore de Compte Roku Account : (a) la date d'achat de Votre Téléviseur ou (b) la date de création de votre Compte Roku. Si vous possédez un compte Roku, tous les appareils que vous choisissez de lier à votre compte Roku et tous les services fournis par Roku qui sont accessibles à l'aide de ces appareils seront soumis à cette convention d'arbitrage. Votre avis doit indiquer votre prénom et nom complets, votre adresse postale, votre numéro de téléphone et votre adresse courriel actuels, le nom du produit et le numéro de série afférent à votre Téléviseur, ainsi qu'une copie de la preuve originale de l'achat de votre Téléviseur. Si vous envoyez en temps opportun un avis en conformité avec le présent paragraphe 6, la convention d'arbitrage ne pourra pas s'appliquer à vous-même ou à Roku. Si vous ne transmettez pas cet avis dans les délais impartis, alors vous consentez à être lié par cette entente d'arbitrage.
- Nonobstant toute disposition contraire de cette Entente, vous reconnaissez que si Roku veut supprimer ou modifier substantiellement l'entente d'arbitrage ci-devant, ladite suppression ou modification ne s'appliquera pas à une Réclamation individuelle pour laquelle vous avez avisé Roku préalablement à ladite suppression ou modification.

## Divers

En vertu de ce CLUF, Roku peut transférer ses droits et ses obligations à une autre organisation. Vous pouvez uniquement transférer vos droits ou vos obligations en vertu de ce CLUF à une autre personne si Roku y consent par écrit. Ce CLUF est entre vous et Roku. Aucune autre personne n'aura le droit de faire respecter ces conditions. Chacun des paragraphes du présent CLUF a effet séparément. Si un tribunal ou une autre autorité compétente décide que l'un d'entre eux est illicite, les paragraphes restants resteront en vigueur. Si Roku ne parvient pas à s'assurer que vous respectez vos obligations aux termes du présent CLUF ou si Roku n'applique pas ses droits contre vous, ou si Roku tarde à le faire, cela ne signifiera pas que Roku a renoncé à ses droits contre vous, ou que vous n'avez pas à vous conformer à ces obligations. Si Roku renonce à intenter un recours en cas de manquement de votre part, Roku ne le fera que par écrit, mais cela ne signifiera pas que Roku renoncera automatiquement à tout manquement ultérieur de vous.

## Coordonnées

Si vous désirez communiquer avec Roku, veuillez nous envoyer votre courrier à l'adresse suivante Roku, Inc., 150 Winchester Circle, Los Gatos, CA 95032, États-Unis ou par courriel à l'adresse [customerservice@roku.com](mailto:customerservice@roku.com).

Dernière mise à jour : 21 avril 2016

## Dolby Audio™

Manufactured under license from Dolby Laboratories. Dolby, Dolby Audio, and the double-D symbol are trademarks of Dolby Laboratories Licensing Corporation.



## HDMI®

The Adopted Trademarks HDMI, HDMI High-Definition Multimedia Interface, and the HDMI Logo are trademarks or registered trademarks of HDMI Licensing Administrator, Inc. in the United States and other countries.



## Roku

Roku, Roku TV, and the Roku logo are the trademarks of Roku, Inc. All other trademarks and logos herein are the property of their respective owners.

