

JVC

HD LED TV

LT-24MAW200 (24" class/ 23.6" diagonal)

USER GUIDE

ENGLISH



ATTENTION

If you purchase a universal remote control from your local retailer, please contact the remote manufacturer for the required programming code.

PLEASE HAVE THE MODEL NUMBER READY PRIOR TO CALLING
FOR RECYCLING INFORMATION, PLEASE CONTACT CUSTOMER SERVICE.

CUSTOMER SERVICE - 1-888-582-8870

Before operating the unit, please read this manual thoroughly.

Contents

Safety and warnings.....	1-3
Introduction.....	4
Installation.....	5-8
Wall Mount.....	9
General Description.....	10-13
External Connection.....	14-17
Menu System Instruction.....	18-21
Trouble Shooting.....	22-23
Reference.....	24

SAFETY AND WARNINGS

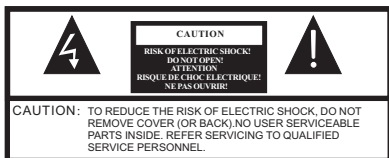

The lightning flash with arrowhead symbol, within an equilateral triangle is intended to alert the user to the presence of uninsulated dangerous voltage within the product's enclosure that may be of sufficient magnitude to constitute a risk of electric shock.



The exclamation point within an equilateral triangle is intended to alert the user to the presence of important operating and maintenance (servicing) instructions in the literature accompanying the appliance.

WARNING: TO PREVENT FIRE OR SHOCK HAZARD, DO NOT EXPOSE THIS APPLIANCE TO RAIN OR MOISTURE.
TO PREVENT THE SPREAD OF FIRE, KEEP CANDLES OR OPEN FLAMES AWAY FROM THIS PRODUCT AT ALL TIMES.

CAUTION: TO PREVENT ELECTRIC SHOCK, DO NOT USE THIS POLARIZED PLUG WITH AN EXTENSION CORD, RECEPTACLE OR OTHER OUTLET UNLESS THE BLADES CAN BE FULLY INSERTED TO PREVENT BLADE EXPOSURE.

WARNING: This equipment has been tested and found to comply with the limits for a Class B digital device, pursuant to Part 15 of the FCC Rules. These limits are designed to provide reasonable protection against harmful interference in a residential installation. This equipment generates, uses and can radiate radio frequency energy and, if not installed and used in accordance with the instructions, may cause harmful interference to radio communications.

However, there is no guarantee that interference will not occur in a particular installation. If this equipment does cause harmful interference to radio or television reception, which can be determined by turning the equipment off and on, the user is encouraged to try to correct the interference by one or more of the following measures:

- Reorient or relocate the receiving antenna.
- Increase the separation between the equipment and receiver.
- Connect the equipment into an outlet on a circuit different from that to which the receiver is connected.
- Consult the dealer or an experienced radio/TV technician for help.

CAUTION: Changes or modifications not expressly approved by the party responsible for compliance with the FCC Rules could void the user's authority to operate this equipment.

THIS DEVICE COMPLIES WITH PART 15 OF THE FCC RULES. OPERATION IS SUBJECT TO THE FOLLOWING TWO CONDITIONS:

(1) THIS DEVICE MAY NOT CAUSE HARMFUL INTERFERENCE, AND (2) THIS DEVICE MUST ACCEPT ANY INTERFERENCE RECEIVED, INCLUDING INTERFERENCE THAT MAY CAUSE UNDESIRE OPERATION.

Location of the required marking

The rating sheet and the safety caution are on the rear of the unit.

BATTERY PRECAUTIONS:

- Batteries should not be exposed to excessive heat such as sunshine, fire or the like.
 - The remote control unit uses infrared beams to transmit signals, so sunlight or fluorescent light on the remote sensor may shorten operating distance.
 - Incorrect use of batteries may cause them to leak or burst. Read the battery warnings and use the batteries properly.
 - Do not mix old and new batteries.
 - Do not mix alkaline, standard (carbon-zinc), or rechargeable, (Ni-Cd, Ni-MH, etc.) batteries.
- Remove batteries if the remote control will not be operated for an extended period of time.

Important Note:

In the spaces below, enter the model and serial number of your television (located at the rear of the television cabinet). Staple your sales receipt or invoice to the inside cover of this guide. Keep this user's guide in a convenient place for future reference. Keep the carton and original packaging for future use.

Serial number: _____

Model number: _____

SAFETY AND WARNINGS

IMPORTANT SAFETY INSTRUCTIONS

Important Safety Instructions

- 1) Read these instructions.
- 2) Keep these instructions.
- 3) Heed all warnings.
- 4) Follow all instructions.
- 5) Do not use this apparatus near water.
- 6) Clean only with non abrasive dry cloth.
- 7) Do not block any ventilation openings, install in accordance with the instructions.
- 8) Do not install near any heat sources such as radiators, heat registers, stoves, or other apparatus (including amplifiers) that produce heat.
- 9) Do not defeat the safety purpose of the polarized plug. If the provided plug does not fit into your outlet, consult an electrician for replacement of the obsolete outlet.
- 10) Protect the power cord from being walked on or pinched particularly at plugs, convenience receptacles, and the point where they exit from the apparatus.
- 11) Only use attachments/accessories specified by the manufacturer.
- 12) Unplug this apparatus during lighting storms or when unused for long periods of time.
- 13) Refer all servicing to qualified service personnel. Servicing is required when the apparatus has been damaged in any way, such as when power-supply cord or plug is damaged, liquid has been spilled or objects have fallen into the apparatus, the apparatus has been exposed to rain or moisture, does not operate normally, or has been dropped.
- 14) Mains plug is used as the disconnect device, the disconnect device shall remain readily operable.
- 15) Do not cover the ventilation openings with items such as newspapers, table-cloth, curtains, etc.
- 16) No naked flame sources, such as lighted candles, should be placed on the apparatus.
- 17) Attention should be drawn to the environmental aspects of battery disposal.
- 18) Use apparatus in moderate climate.
- 19) The apparatus shall not be exposed to dripping or splashing and that no objects filled with liquids, such as vases, shall be placed on the apparatus.
- 20) Use only with a cart, stand, tripod, bracket, or table specified by the manufacturer, or sold with the apparatus. When a cart is used, use caution when moving the cart/apparatus combination to avoid injury from tip-over.



The symbol indicates that dangerous voltages constituting a risk of electric shock are present within this unit.



The symbol indicates that there are important operating and maintenance instructions in the literature accompanying this unit.

WARNING:

To reduce the risk of fire or electric shock, do not expose this apparatus to rain or moisture.

WARNING:

The batteries shall not be exposed to excessive heat such as, fire or the like.

WARNING:

The excessive sound pressure from earphones and headphones can cause hearing loss.



This symbol indicates that this product incorporates double insulation between hazardous mains voltage and user accessible parts. When servicing use only identical replacement parts.



This marking indicates that this product should not be disposed with other household wastes. To prevent possible harm to the environment or human health from uncontrolled waste disposal, recycle it responsibly to promote the sustainable reuse of material resources. To return your used device, please use the return and collection systems or contact the retailer where the product was purchased. They can take this product for environmental safe recycling.

SAFETY AND WARNINGS

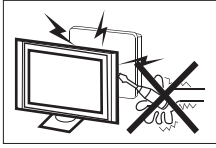

High voltages are used in the operation of this television receiver. Do not remove the cabinet back from your set. Refer servicing to qualified service personnel.

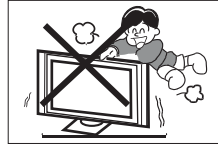

Never stand on, lean on, or suddenly push the television or its stand. You should pay special attention to children. Serious injury may result if it falls.

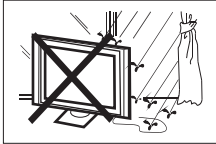

To prevent fire or electrical shock hazard, do not expose the television receiver to rain or moisture.

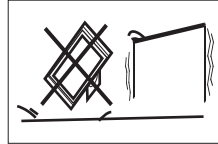

Do not place your television on an unstable cart, stand, shelf or table. Serious injury to an individual, and damage to the television, may result if it falls. Recommended to utilize rear mount screw holes for anti-tipping (hardware not included).

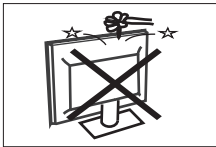

Do not drop or push objects into the television cabinet slots or openings. Never spill any kind of liquid on the television receiver.

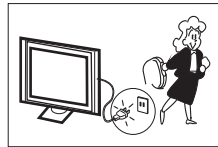

When the television receiver is not used for an extended period of time, it is advisable to disconnect the AC power cord from the AC outlet.



Do not block the ventilation holes in the back cover. Adequate ventilation is essential to prevent failure of electrical components.

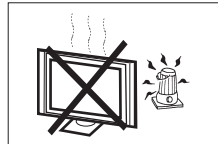

Avoid exposing the television receiver to direct sunlight and other sources of heat. Do not stand the television receiver directly on other products which give off heat, e.g. video cassette players and audio amplifiers. Do not place naked flame sources, such as lighted candles on the television.



Do not trap the power supply cord under the television receiver.

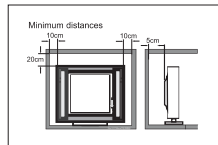

If the television is to be built into a compartment or similar enclosure, the minimum distances must be maintained. Heat build-up can reduce the service life of your television, and can also be dangerous.

INTRODUCTION

Antenna

Main features

- 24" wide screen for a complete experience
- Super slim LCD TV with LED backlight
- 1366x768 native resolution for HD performance
- Integrated ATSC TV tuner for HDTV broadcast reception
- HDMI® inputs for true digital connections

Accessories

Power Cable.....	1
Infrared Remote Control.....	1
User's Manual	1
Battery(AAA)	2
Screws.....	4
Base stand.....	2
Component adaptor cable.....	1

Specifications

Viewing PictureSize(diagonal)	24" class (23.6" diagonal)
Resolution:	1366 x 768
AspectRatio:	16:9
TV System:	ATSC Digital system and NTSC Analog system
Video Signal System:	NTSC
Receiving Channel:	Cable :1-135/ Air: 2-69(ATV&DTV)
Power Consumption:	25W
Input Power Voltage:	100-240V~ 50/60Hz
Audio OutputPower(THD≤ 7%):	2 x 3W
High-Definition Multimedia Interface(HDMI) Input	x 3
YCb(Pb)Cr(Pr)Input	x 1
Composite Video Input	x 1
Audio Input	x 1
Headphone Output	x 1
Optical	x 1
USB 2.0 Input	x 1
VGA Input	x 1
Dimensions (approx) with stand fitted(WxDxH)	550 x 180 x 368 mm 21.6 x 7.1 x 14.5 inch
Net weight	2.7 kg (5.95 lbs) with STAND



The Adopted Trademarks HDMI, HDMI High-Definition Multimedia Interface, and the HDMI Logo are trademarks or registered trademarks of HDMI Licensing Administrator, Inc. in the United States and other countries.

Manufactured under license from Dolby Laboratories. Dolby, Dolby Audio, and the double-D symbol are trademarks of Dolby Laboratories.

"This product is manufactured, distributed, serviced and warranted exclusively by SHENZHEN MTC CO., LTD.. "JVC" is the trademark of JVC KENWOOD Corporation, used by such company under license."

INSTALLATION

Front panel

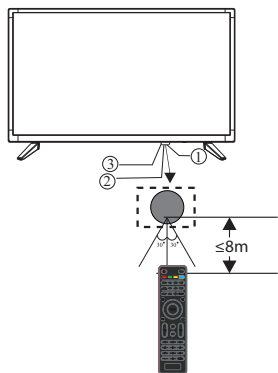

- 1: Remote control sensor.
- 2: Indicator LED: RED ● STANDBY.
- 3: Key board

KEYBOARD

The keyboard is located at the bottom left near the right side of signal indicator.

Rocker

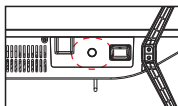

Bottom

TV Status	Press
Power off	Power to power on.
Power on	-Short press to select source, then press again to select the channel you want, wait a few seconds to jump to the source. -Long press to power off.

REAR Connections



All the terminals are (from left to right): VGA, RF INPUT, USB, OPTICAL OUTPUT.

SIDE Connections



All the terminals are (from left to right):

HEADPHONE, VIDEO, AUDIO INPUT, YPbPr INPUT, HDMI3, HDMI2(ARC), HDMI1.

INSTALLATION

Antenna

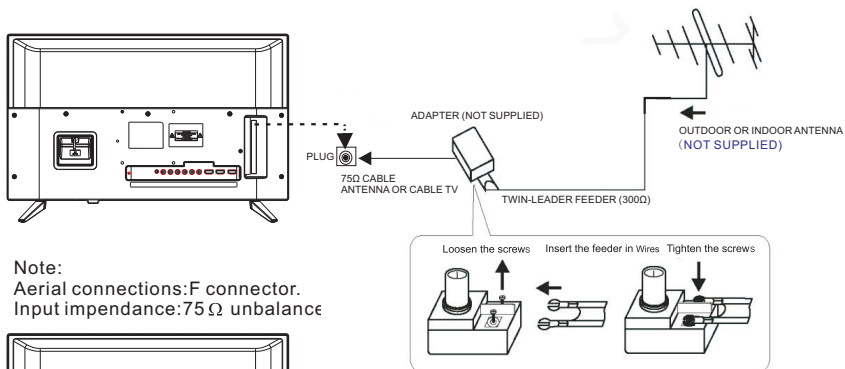

Note:
Aerial connections: F connector.
Input impedance: 75 Ω unbalance

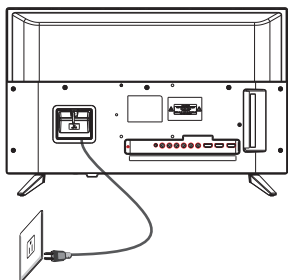

Power connection

Please note: After unpacking, allow the TV to reach ambient room temperature before connection the TV to the mains power socket.
Connect the power cord plug to the mains power socket.

PRESET MODE (HDMI)

	RESOLUTION	V.Freq.(Hz)	H.Freq.(KHz)
1	800*600	60	37.88
2	1024*768	60	48.36
3	1366*768	60	47.7
4	1280*768	60	47.3
5	1920*1080	60	67.5

CABLE

When shipped from the factory, the Signal Type option is for the RF connector (F-type) set to the "AIR" (Over-the air antenna) mode.

INSTALLATION

Base Stand Assembly Instruction

The base stand

Prepare to place the TV with the display side down on a flat surface. Due to the size and weight of this TV, the use of 2 people is recommended when moving it. Ensure the table or desk you use provides a flat, totally clean surface, and use a soft cloth between the face of the TV and the table to protect the TV's screen.

1. Locate the 2PCS of the base stand and insert it into the gap in the bottom of the TV , and check that it is securely held in place as per a) below.

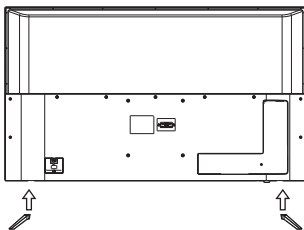

a)

2. Lock 4 screws in the designated location as per b) below and check each screw is firmly tightened.

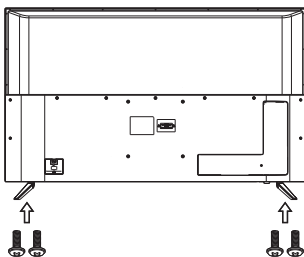

b)

4 x Screws(3X12MM)

INSTALLATION

AV Equipment

You can use the rear input terminals as follows.

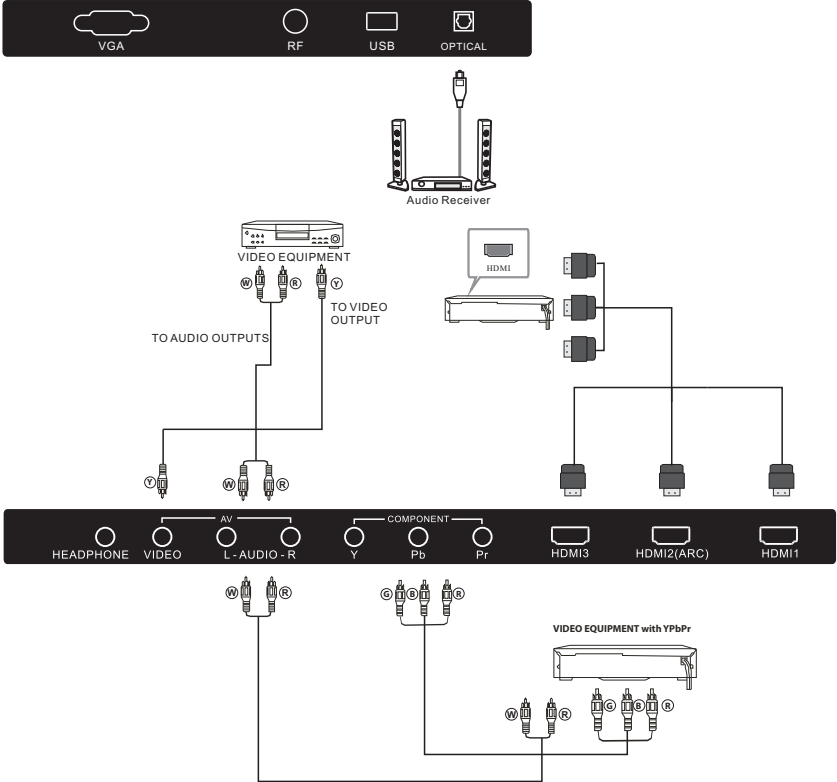

Video Equipments: VCR, Multi Disc Player, DVD Player, Camcorder, Video Game, etc.
Video format that YPbPr supports: 480i, 576i, 480p, 720p, 1080i, 1080p.

Wall Mount

Instruction for Wall Mount

A wall mount kit (purchased separately) would allow you to mount your JVC TV on the wall. For detailed information on installing the wall mount, refer to the instructions provided by the wall mount manufacturer. It is strongly recommended to contact a technician for professional assistance for wall mount installation. JVC is not responsible for any damage to the product or injury to yourself or others resulting from the wall-mounting.

Dimensions for Mounting Hole Pattern

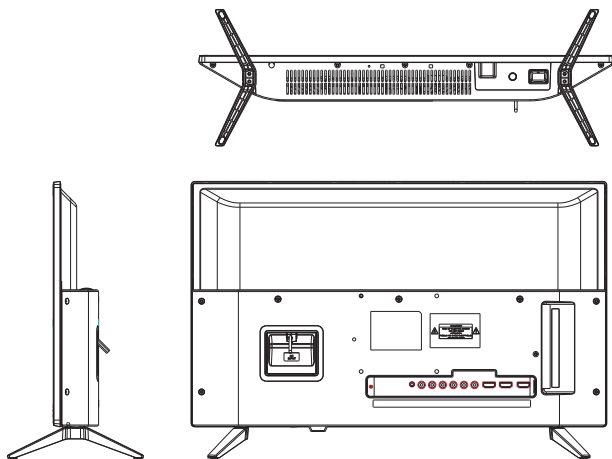

This JVC TV is compatible with a 100mm x 100mm mounting hole pattern.

- 4 pcs of type M4 screws are required for installing the wall mount bracket to your JVC TV. Do not use screws that are longer than 5 mm. Screws that are too long may cause damage to the inside of the TV set.
- Do not fasten the screws too tight for this may damage the TV or cause the TV to fall, resulting in personal injury. JVC is not liable for these kinds of incidents.
- Do not mount your JVC TV at more than a 15 degree tilt.
- Always use two people to mount the TV to a wall.
- Do not install your Wall Mount Kit while your TV is turned on. It may result in personal injury due to electric shock.

General Description

Overview of remote control

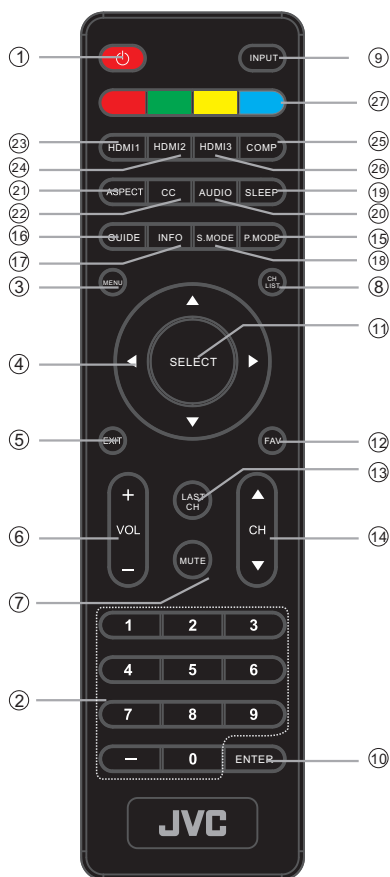

Loading batteries:

- 1) Remove the lid of the battery compartment.
- 2) Insert 2 size AAA batteries with polarities as indicated inside the compartment.
- 3) Replace the lid.

Note:

- 1) A loading of batteries should be last one year under normal use.
- 2) If you don't intend to use the remote control for a long period of time, remove batteries to avoid damage due to leakage.
- 3) Do not mix old and new batteries or different types.
- 4) Do not throw batteries into fire or water.
- 5) The batteries (battery pack or batteries installed) should not be exposed to excessive heat such as sunshine, fire or the like.

General Description

Overview of remote control

1. **POWER:** To set the TV standby or on.
2. **NUMBER KEY:** For direct access to program.
3. **MENU:** Displays the main on-screen menu.
4. **CURSOR:** To move within the menu.
5. **EXIT:** Used to exit menu.
6. **VOL +/- :** To adjust sound level.
7. **MUTE:** To disable or enable the sound.
8. **CH.LIST:** Used to display the channel list.
9. **INPUT:** Press to change the TV's input.
10. **ENTER:** Confirms selection.
11. **SELECT:** Press to enter or select functions for the On-Screen menu.
12. **FAV:** Used to access your favourite channels in digital TV mode.
13. **LAST CH:** Pressing this button allow you to go back to the previous channel selected. Press this button again to return to the channel you were watching.
14. **CH▲/CH▼:** To access the next or previous program.
15. **P.MODE:** To switch picture mode.
16. **GUIDE:** Press to display the program guide for DTV channels.

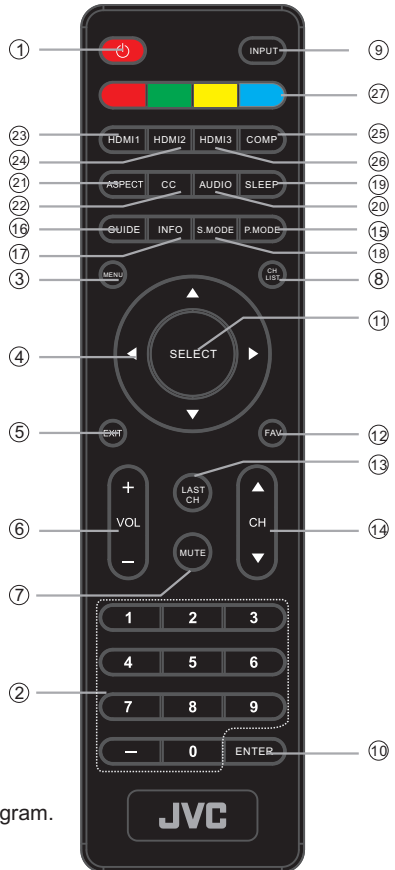

General Description

Overview of remote control

17. **INFO**: When you press this button, the current information will be displayed on the screen.

18. **S.MODE**: Used to access your favourite channels in digital TV mode.

19. **SLEEP**: Press to set the sleep timer.

20. **AUDIO**: Press to change the audio language.

21. **ASPECT**: To change picture aspect.

22. **CC**: Enable or disable the CC function.

23. **HDMI1**: Press to directly access the HDMI1 input.

24. **HDMI2**: Press to directly access the HDMI2 input.

25. **COMP**: Press to directly access the Component input.

26. **HDMI3**: Press to directly access the HDMI3 input.

27. **COLOR KEYS**: Reserved keys.

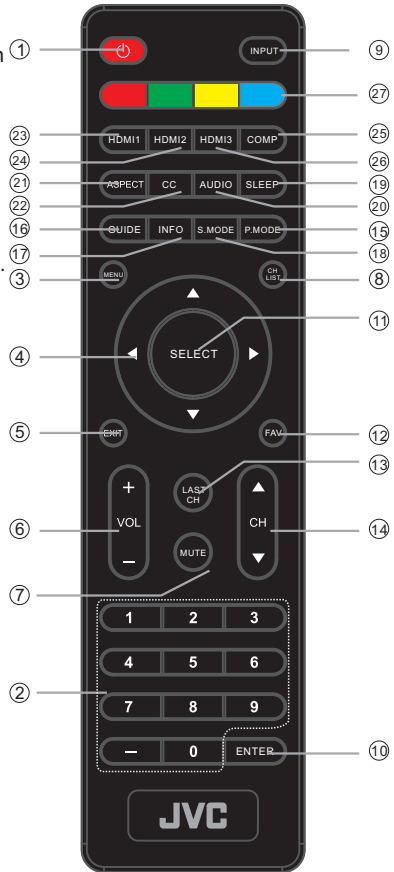

General Description

Installing Batteries in the Remote Control

Installing Batteries

- 1** Open the battery compartment cover on the back side.

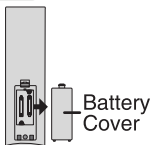

- 2** Insert two 1.5V AAA size batteries in correct polarity. Don't mix old or used batteries with new ones.

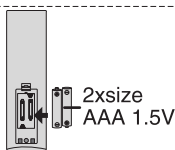

- 3** Closed the cover.

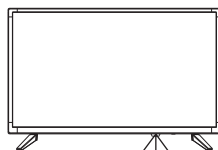
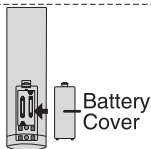

30° 30°



- ✦ Point the remote towards the remote control sensor of the TV and use it within 8 meters.
- ✦ Put the used batteries into the recycling bin since they can negatively affect the environment.

Note:

- One loading of batteries will last for 1 year under normal use.
- If you do not intend to use the remote controller for a long period of time, remove them to avoid damage due to leakage.
- Do not use old and new batteries together.
- The batteries (battery pack or batteries installed) shall not be exposed to excessive heat such as sunshine, fire or the like.

External Connection

Antenna connection

Antenna input impedance of this unit is 75ohm. VHF/UHF 75ohm coaxial cable can be connected to the antenna jack directly, if the antenna cable is 300ohm parallel flat feeder cable, you need to use the 300ohm/75ohm converter to connect the antenna cable to the antenna jack. For details Please refer to the following drawing.

Antennas with 300 Ω flat twins Leads

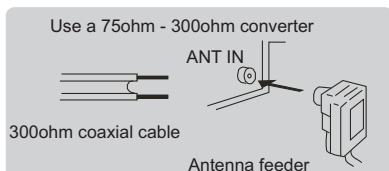

Antennas with 75 Ω Round Leads

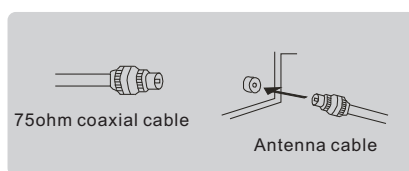

External Connection

Connecting VCR

These instructions assume that you have already connected your TV to an antenna or a cable TV system. Skip step 1 if you have not yet connected to an antenna or a cable system.

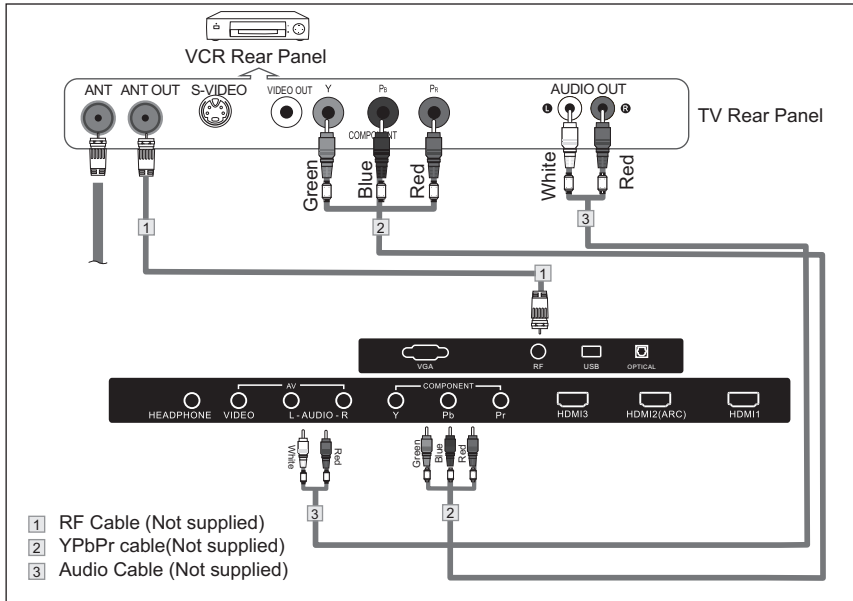

Follow the instructions in Viewing a VCR or Camcorder Tape to view your VCR tape.

Each VCR has a different back panel configuration.

When connecting a VCR, match the color of the connection terminal to the cable.

1. Unplug the cable or antenna from the back of the TV.
2. Connect the cable or antenna to the ANT IN terminal on the back of the VCR.
3. Connect an RF Cable between the ANT OUT terminal on the VCR and the ANT IN terminal on the TV.
4. Connect a Component Cable between the COMPONENT [Y, Pb, Pr] jacks on the DVD player and YPbPr jack on the TV.
5. Connect Audio Cables between the AUDIO OUT jacks on the VCR and the AUDIO L and AUDIO R jacks on the TV.

Note:

1. Whenever you connect an external device to your TV, make sure that power on the unit is turned off.
2. When connecting an external device, match the color of the connection terminal to the cable.

External Connection

Connecting a Camcorder

The rear panel jacks on your TV make it easy to connect a camcorder to your TV. They allow you to view the camcorder tapes without using a VCR.

Each Camcorder has a different back panel configuration.

When connecting a Camcorder or DVD, match the color of the connection terminal to the cable.

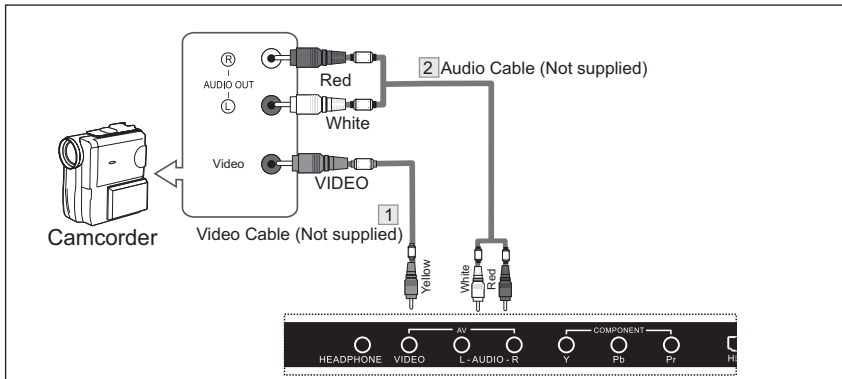

1. Connect a Video Cable between the AV VIDEO in jacks on the TV and the VIDEO OUT jack on the camcorder.
2. Connect Audio Cables between the AUDIO L and AUDIO R jacks on the TV and the AUDIO OUT jacks on the camcorder.
3. Connect a Video Cable between the AV VIDEO IN jacks on the TV and the VIDEO OUT jack on the DVD.
4. Connect Audio Cables between the component IN AUDIO L and R jacks on the TV and the AUDIO OUT jack on the DVD.

Notes:

1. **Whenever you connect an external device to your TV, make sure that power on the unit is turned off.**
2. **When connecting an external device, match the color of the connection terminal to the cable.**

External Connection

Connecting Digital Audio System

This connection can only be made if there is a HDMI Output connector on the external device.

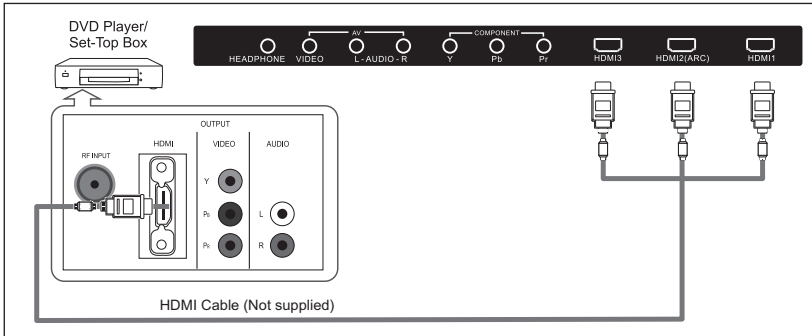

What is HDMI?

HDMI, or high-definition multimedia interface, is a next-generation interface that enables the transmission of digital audio and video signals using a single cable without compression. Multimedia interface is a more accurate name for it especially because it allows multiple channels of digital audio.

The difference between HDMI and DVI is that the HDMI device is smaller in size, has the HDCP (High Bandwidth Digital Copy Protection) coding feature installed, and supports multi-channel digital audio.

Each DVD player/STB has a different back panel configuration.

Connect an HDMI Cable between the HDMI1, HDMI2, HDMI3 connector on the TV and the HDMI connector on the DVD player/Set-Top Box.

Notes:

1. Whenever you connect an external device to your TV, make sure that power on the unit is turned off.
2. When connecting an external device, match the color of the connection terminal to the cable.

External Connection

Connecting Digital Audio

The rear panel jacks on your TV make it easy to connect a Digital Audio System to your TV.

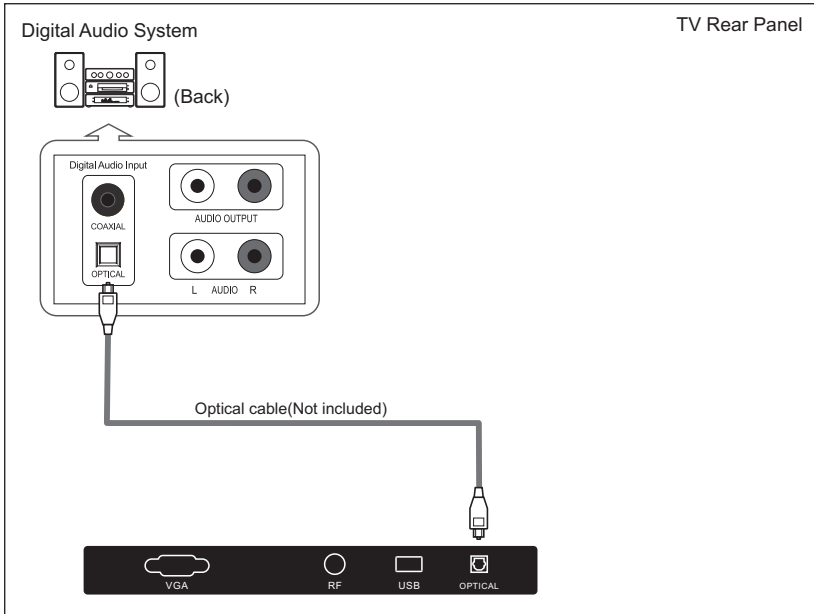

5.1 CH audio is possible when the TV is connected to an external device supporting 5.1 CH. Connect an OPTICAL Cable between the OPTICAL jacks on the TV and the Digital Audio Input jacks on the Digital Audio System. When a Digital Audio System is connected to the OPTICAL terminal: Decrease the gain (volume) of the TV, and adjust the volume level with the Digital Audio System's volume control.

Supporting Signals

Input	Mode
Digital	ATSC
Analogue	PAL-M/PAL-N/NTSC M
CVBS	PAL/NTSC



Input	Resolution	Vertical Frequency
Component	480i	60Hz
	480p	60Hz
	720p	50Hz/60Hz
	1080i	50Hz/60Hz
HDMI	480p	60Hz
	720p	50Hz/60Hz
	1080i	50Hz/60Hz
	1080p	50Hz/60Hz

Menu system instruction

Menu Operation

1. PICTURE MENU

In this menu, you can adjust the picture effect here, such as contrast, brightness, etc.
Press **▼▲** to select, press **ENTER** to adjust.

* Only under TV source, menu will show 
Under AV/Component/HDMI1/HDMI2/HDMI3/
VGA/USB, menu will not show .

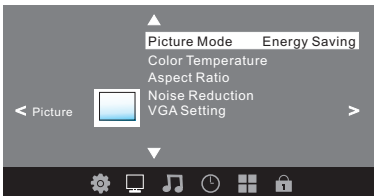

Note: The TV may not conform to the Energy Star standard after Picture Mode is changed except Energy Saving.

1.1 VGA Setting

When PC Mode is available.
Press **ENTER** button to select PC advanced setting

- 1) H-Pos: Adjust the horizontal position of the screen.
- 2) V-Pos: Adjust the vertical position of the screen.
- 3) Size: Fine tune the screen width.
- 4) Phase: Fine tune the phase of the screen. Usually don't adjust this item.
- 5) Auto: Auto adjust to fit the screen.

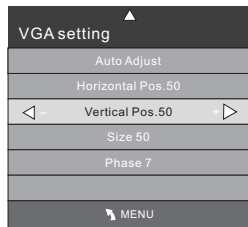

Note:

- 1) If you want to adjust contrast, brightness, color, and sharpness, the picture mode must return to personal status.
- 2) Tint is available in NTSC system only.
- 3) There are three color temperature modes can be selected: Normal, Warm and Cool.

2. AUDIO MENU

In this menu, you can adjust the sound effect here.
Press **▼▲** to select, press **ENTER** to adjust.

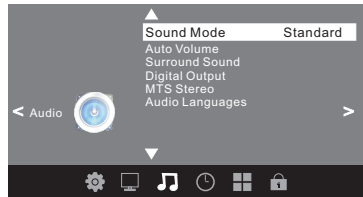

Note:

- 1) There are five Sound Modes can be selected: Standard, Music, Movie, Sports and Personal
- 2) Audio language is available in ATSC/TV Programming only.
- 3) Auto volume is available only when the input signal volume is too large or there is distortion.

3. TIME MENU

In this menu, you can adjust the sleep timer, time zone, etc. Press **▼▲** to select, press **ENTER** to adjust.



Note:

- 1) Time zone, DST and the clock are available in ATSC programming only, and the Clock can't be adjust.

4. OPTION MENU

In this menu, you can adjust the Menu language, Close Caption, Restore Default etc. Press **▼▲** to select, press **ENTER** to adjust.

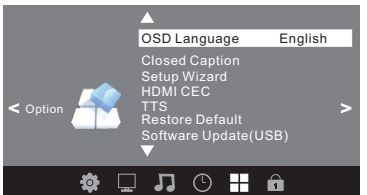

Menu system instruction

Menu Operation

4.1 Closed Caption

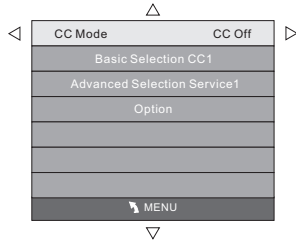

- 1) CC Mode: Switching close caption mode.
- 2) Advanced selection: only ATSC program is available.
- 3) Option: Used to edit CC font.

Note:

- 1) Restore Default: Restore Default will clear all the programs and reset all the settings to default value.

5. LOCK MENU

In this menu, you can change the password and adjust the V-chip setting. Enter the password, it will go into the lock menu. Factory default password is 0000.

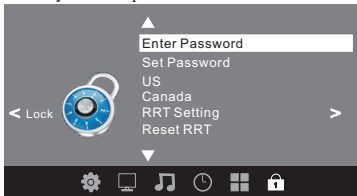

5.1 Enter Password

Enter password, if the Lock System switch is ON, the options listed can be adjusted

5.2 Set Password

- 1) Enter old password: Input the old password.
- 2) Enter new password: Input the new password.
- 3) Confirm password: Input the new password again.

5.3 US

Press ENTER button the screen will display as follow.

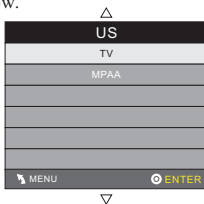

- 1) TV: Press ENTER button, the screen will display as follows:

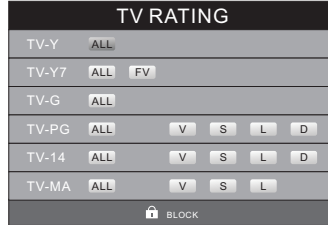

Rating	Content	Content				
		FV (Fantasy violence)	V (Violence)	S (Sexual situation)	L (Adult language)	D (Sexually suggestive dialog)
Suggested age	TV-Y (All children)					
	TV-Y7 (Direct to order children)	X				
	TV-G (General audience)					
	TV-PG (Parental Guidance suggested)		X	X	X	X
	TV-14 (Parents strongly cautioned)		X	X	X	X
	TV-MA (Mature audience only)		X	X	X	

And use the ENTER key to switch lock/ unlock Parental Control feature.

- 2) MPAA: Switching the movie-rating control level; N/A, G, PG, PG-13, R, NC-17, X.

Rating	Description
G	General audiences, All Ages admitted
PG	Parental Guidance suggested. Some material may not be Suitable for children.
PG-13	Parents strongly cautioned. Some material .may be Inappropriate for children under 13.
R	Restrict. Under 17 requires accompanying parent or adult guardian (age varies in some jurisdictions)
NC-17	No one 17 and under admitted.
X	X is an order rating that is unified with NC-17 but may be encoded in the data of order movies.

5.4 Canada

Press ENTER button, the screen will be displayed as follow:



Menu system instruction

1) Canada English: Switching the English rating control level: C, C8+, G, PG, 14+, 18+.

Rating	Description
C	Children: Intended for younger children under the age of 8 years. Pays careful attention to themes that could threaten their sense of security and well-being.
C8+	Children over 8 years old: Contains no portrayal of violence as the preferred, acceptable, or only way to resolve conflict; nor encourage children to imitate dangerous acts which they may see on the screen.
G	General: Considered acceptable for all age groups. Appropriate viewing for the entire family, contains very little violence, physical, verbal or emotional.
PG	Parental Guidance: Intended for a general audience, but may not be suitable for younger children (under the age of 8) because it could contain controversial themes or issues.
14+	Over 14 Years: Could contain themes where violence is one of the dominant elements of the storyline. But it must be integral to the development of plot or character. Language usage could be profane and nudity, present within the context of theme.
18+	Adults: Intended for viewers 18 years and older and might contain depictions of violence, which while related to the development of plot, character or themes, are intended for adult viewing. Could contain graphic language and portrayals of secretary and nudity.

2) Canada French: Switching the French-rating control level: G, 8ANS+, 13ANS+, 16ANS+, 18ANS+.

Rating	Description
G	General: All ages and children, contains minimal direct violence, but may be integrated into the plot in a humorous or unrealistic manner.
8ans+	General but inadvisable for young children: May be viewed by a wide public audience, but could contain scenes disturbing to children under 8 who cannot distinguish between imaginary and real situations. Recommended for viewing with parents.
13ans+	Over 13 years: Could contain scenes of frequent violent scenes and intense violence.
16ans+	Over 16 years: Could contain frequent violent scenes and violence.
18ans+	Over 18 years: Only for adult viewing. Could contain frequent violent scenes and extreme violence.

5.5 RRT setting

It can be adjusted when the TV is in ATSC digital mode and the TV stream have RRT information.

5.6 Reset RRT

It can be adjusted when the TV is in ATSC digital mode and the TV stream have RRT information.

6. CHANNEL MENU

In this menu, you can adjust digital and analog TV Channels.

Press **▼▲** to select, press **ENTER** to adjust.

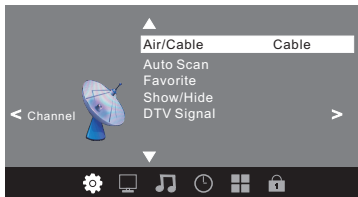

6.1 Air/Cable:

Select Air TV signal and cable TV signal.

6.2 Auto Scan:

If it's the first time you use the TV, you should scan all the TV channels first,

Press **ENTER** button to confirm, you will see the menu.

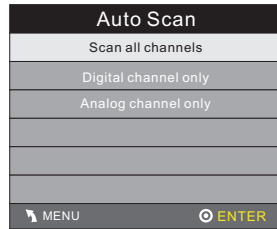

When you select "Scan all channels", you will watch below indication which auto scan is in progress.

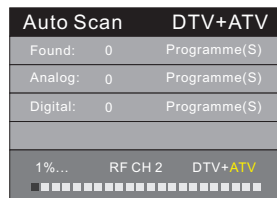

6.3 Favorite:

Press **ENTER** button to choose/delete the favorite channel.

6.4 Show/Hide

Press **ENTER** button to display or hide current channel.

6.5 DTV signal

Display DTV strength signal. It can't be selected and adjusted.

7. Displaying JPEG files by using USB Port

You can display the JPEG files by using the USB port that is located on the rear panel:

7.1 Connect the USB DEVICE that contains the JPEG files.

7.2 Press **SOURCE** to enter inputsource menu.

7.3 In the inputsource menu, Press **▼▲◀▶** to select USB, and then press **ENTER**.

Menu system instruction

Input Source
HDMI1
HDMI2
HDMI3
TV
Component
VGA
AV
USB
ENTER

7.4 Press ▼▲◀▶ to select Photo, and then press enter



7.5 Press ▼▲◀▶ to select folder which contains JPEG picture .



7.6 Press ENTER to display the picture in the folder.

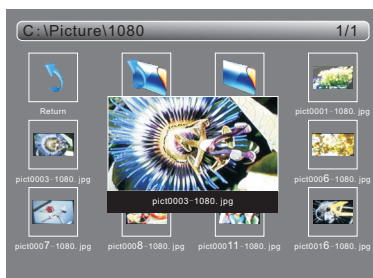

Troubleshooting

If you have any problem, check the counter measures for each symptom listed below. The following symptoms may have been caused by inappropriate adjustment rather than actual malfunction of the unit. If the trouble persists, contact the Customer Care Centre, see back page for contact details.

Symptoms	Possible solutions
No power	Please check the power cord plugged in and that the power outlet works. Unplug the power cord and plug it in after 60 seconds and restart the TV.
No picture	Please check antenna connection. Station may be experiencing problems, please tune to another station. Please adjust the settings of contrast and brightness.
Good picture but no sound	Please increase the volume. Please check TV is under mute mode, press MUTE button on the remote control. Please check sound settings If external devices are being used, check their volumes are not set too low or turned off. If using AVI or Component inputs, please make sure cables are connected properly and not loose.
Good sound but abnormal color or no picture	Please check antenna connection and antenna condition. If using Component input, please check Component connections, incorrect or loose connections may cause colour problems or cause the screen to be blank.
No response to remote control	Batteries of remote control may have exhausted, if necessary, please change the batteries. Clean the remote control lens. The distance between LED TV and remote control should be within 8m, within recommended operating angle and path is free of obstructions.
Colored dots may be present on the screen	Although the LED screen is made with high-precision technology and 99.99% or more of the pixels are effective, black dots may appear or bright points of light (red, blue, or green) may appear constantly on the LED screen. This is a structural property of the LED screen and not a malfunction.
Picture is breaking up	Keep the TV away from noisy electrical sources such as cars, hair dryers, welders, and all optional equipment. Electrical atmospheric interference such as local or distant lightning storms may cause picture to break up. When installing optional equipment, leave some space between the optional equipment and the TV. Check the antenna and connection. Keep the antenna away from any power or input/output cables.
After Auto Tuning only some channels are available	Check your area is covered by Digital Video Broadcasts. Try re-tuning or manually tuning missing channels. Check that you are using the correct antenna type - please see pg.16 'Antenna connection'.

Troubleshooting

Channel cannot be selected	Check if the channel has been blocked in the main menu settings.
USB not playing	Please check connecting USB cable and power supply is connected. Hard drive has not been formatted. Please make sure USB disk is compatible and the multimedia data formats are supported.
Picture is distorted, macroblock, small block, dots, pixelization, etc	Compression of video contents may cause distortion especially on fast moving pictures such as sports and action movies.
Noise from speaker	Check cable connections, make sure a video cable is not connected to an audio input. Low signal level may cause sound distortion.
TV turns on automatically	Check if the On Timer is set to On in the Setup menu.
Picture is not shown in full screen	Black bars on each side will be shown on HD channels when displaying SD (4:3) contents. Black bars on Top & Bottom will be shown on movies that have aspect ratios different from your TV. Adjust picture size option on your external device or TV to full screen.

WARNING

Never place a television set in an unstable location. A television set may fall, causing serious personal injury or death. Many injuries, particularly to children, can be avoided by taking simple precautions such as:

- Using cabinets or stands recommended by the manufacturer of the television set.
- Only using furniture that can safely support the television set.
- Ensuring the television set is not overhanging the edge of the supporting furniture.
- Not placing the television set on tall furniture (for example, cupboards or bookcases) without anchoring both the furniture and the television set to a suitable support.
- Not placing the television set on cloth or other materials that may be located between the television set and supporting furniture.
- Educating children about the dangers of climbing on furniture to reach the television set or its controls

If your existing television set is being retained and relocated, the same considerations as above should be applied.

The plug or appliance coupler is used as the disconnect device, the disconnect device shall remain readily operable.

Reference

Picture defects and the reason



Snowy Picture

Snowy picture is usually due to weak signal. Adjust antenna or install an antenna amplifier.



Double Image or Ghosts

Double images are usually caused by reflections from tall buildings. Adjust the direction of the antenna or raise it.



Radio Wave Interference

Wave patterns are moving on the screen, which are usually caused by nearby radio transmitters or short-wave receiving equipment.



High Temperature Electrothermal Interference

Diagonal or herringbone patterns appear on the screen or part of picture is missing. This is probably caused by high temperature electrothermal equipment in a nearby hospital.



JVC



4 0 3 1 Q2 3 6 2 1 1

Printed in China